

# EIKI

MULTIMEDIA PROJECTOR

## MODEL LC-XB41

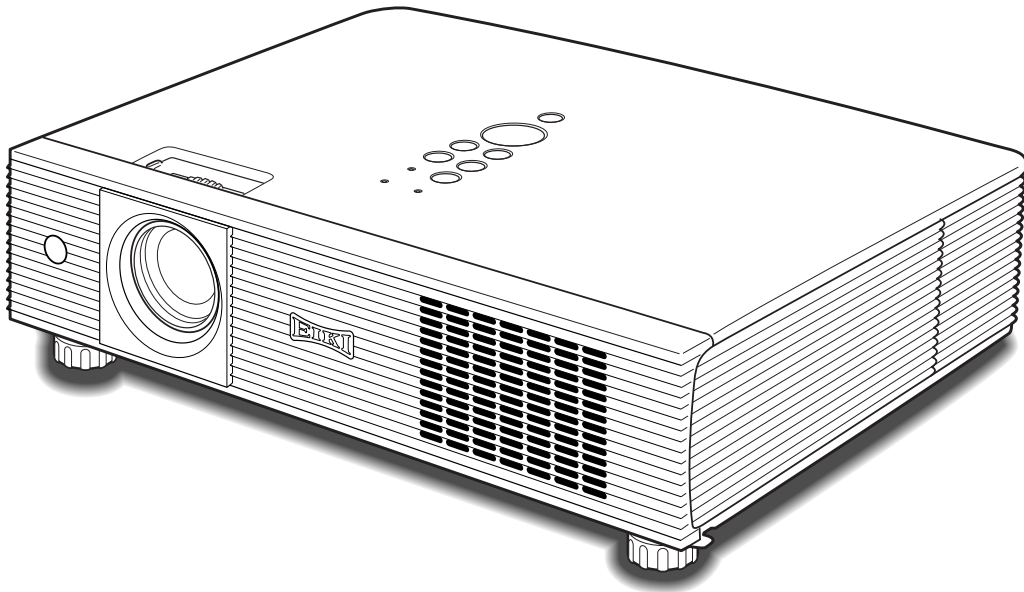

## OWNER'S MANUAL

# Features and Design

---

This Multimedia Projector is designed with the most advanced technology for portability, durability, and ease of use. This projector utilizes built-in multimedia features, a palette of 16.77 million colors, and matrix liquid crystal display (LCD) technology.

## ◆ **Compact Design**

---

This projector is designed compact in size and weight. It is easy to carry and work anywhere you wish to use.

## ◆ **Compatibility**

---

The projector widely accepts various video and computer input signals including; Computers, 6 Color systems (PAL, SECAM, NTSC, NTSC4.43, PAL-M, PAL-N) video, Component video, S-Video and RGB scart.

Useful Interface;

- 2 Inputs for RGB (D-sub 15pin)
- Monitor Output for RGB (D-sub 15pin)
- Audio Output (Mini jack stereo, variable)

## ◆ **Simple Computer System Setting**

---

The projector has the Multi-scan system to conform to almost all computer output signals quickly. (p.27)

## ◆ **Useful Functions for Presentations**

---

- The digital zoom function allows you to focus on the crucial information during a presentation (p.34).
- Blackboards\* can be used as a projection screen.  
\*The board color is limited to Green (pp.31, 38).

## ◆ **Capable of 360-degree Projection**

---

This projector is capable of 360-degree projection.  
\*Some restriction required, see page 7.

## ◆ **Helpful Maintenance Functions**

---

Lamp and filter maintenance functions provide for better and proper maintenance of the projector.

## ◆ **Multilanguage Menu Display**

---

Operation menu is available in 16 languages; English, German, French, Italian, Spanish, Portuguese, Dutch, Swedish, Finnish, Polish, Hungarian, Romanian, Russian, Chinese, Korean, or Japanese. (p.42)

## ◆ **Logo Function**

---

The Logo function allows you to customize the screen logo with the Logo functions. (pp.43, 44) You can capture an image for the screen logo, choose a logo between provided and captured.

## ◆ **Power Management**

---

The Power management function reduces power consumption and maintains the lamp life. (p.46)

## ◆ **Lamp Control**

---

Brightness of the projection lamp can be selected. (p.46)

## ◆ **Security Function**

---

The Security function helps you to ensure the security with the Key lock (p47) and the PIN code lock (p19, 48) functions. You can lock the operation on the projector and the remote control. Also you can prevent unauthorized persons from using the projector.

## ◆ **Input Search Function**

---

Input signal can be searched automatically. (p.45)

## ◆ **Quick Termination**

---

The AC power cord can be unplugged immediately after turning off the projector without waiting for the termination of the cooling fan rotation (p.20).

### ✓ **Notes:**

- The On-Screen Menu and figures in this manual may differ slightly from the product.
- The contents of this manual are subject to change without notice.

# Table of Contents

<b>Features and Design</b> .....	<b>2</b>	<b>Computer Input</b> .....	<b>26</b>
<b>Table of Contents</b> .....	<b>3</b>	Input Source Selection	26
<b>To the Owner</b> .....	<b>4</b>	Computer System Selection	27
<b>Safety Instructions</b> .....	<b>5</b>	Auto PC Adjustment	28
Air Circulation	6	Manual PC Adjustment	29
Moving the Projector	6	Image Mode Selection	31
Installing the Projector in Proper Directions	7	Image Adjustment	32
<b>Compliance</b> .....	<b>8</b>	Screen Size Adjustment	33
<b>Part Names and Functions</b> .....	<b>9</b>	<b>Video Input</b> .....	<b>35</b>
Front	9	Input Source Selection (Video, S-Video)	35
Back	9	Input Source Selection (Component, RGB Scart 21-pin)	36
Bottom	9	Video System Selection	37
Rear Terminal	10	Image Mode Selection	38
Top Control	11	Image Adjustment	39
Remote Control	12	Screen Size Adjustment	41
Remote Control Battery Installation	13	<b>Setting</b> .....	<b>42</b>
Remote Control Operating Range	13	Setting	42
<b>Installation</b> .....	<b>14</b>	<b>Maintenance and Cleaning</b> .....	<b>51</b>
Positioning the Projector	14	Warning Indicator	51
Adjustable Feet	14	Cleaning the Filter	52
Connecting to a Computer	15	Resetting the Filter Counter	52
Connecting to Video Equipment	16	Slide Shutter	53
Connecting to Component Video Equipment	17	Cleaning the Projection Lens	53
Connecting the AC Power Cord	18	Cleaning the Projector Cabinet	53
<b>Basic Operation</b> .....	<b>19</b>	Lamp Replacement	54
Turning On the Projector	19	Resetting the Lamp Counter	55
Turning Off the Projector	20	<b>Appendix</b> .....	<b>56</b>
How to Operate the On-Screen Menu	21	Troubleshooting	56
Menu Bar	22	Menu Tree	58
Zoom and Focus Adjustment	23	Indicators and Projector Condition	60
Sound Adjustment	23	Compatible Computer Specifications	61
Remote Control Operation	24	Technical Specifications	62
		Optional Parts	63
		Configurations of Terminals	64
		Dimensions	64
		PIN Code Number Memo	65

---

## Trademarks

Each name of corporations or products in this book is either a registered trademark or a trademark of its respective corporation.





# To the Owner

Before installing and operating this projector, read this manual thoroughly.

This projector provides many convenient features and functions. Operating the projector properly enables you to manage those features and maintains it in good condition for many years to come.

Improper operation may result in not only shortening the product-life, but also malfunctions, fire hazard, or other accidents.

If your projector seems to operate improperly, read this manual again, check operations and cable connections and try the solutions in the "Troubleshooting" section in the back of this booklet. If the problem still persists, contact the dealer where you purchased the projector or the service center.

	<b>CAUTION</b> <b>RISK OF ELECTRIC SHOCK</b> <b>DO NOT OPEN</b>	
<b>CAUTION: TO REDUCE THE RISK OF ELECTRIC SHOCK, DO NOT REMOVE COVER (OR BACK). NO USER-SERVICEABLE PARTS INSIDE EXCEPT LAMP REPLACEMENT. REFER SERVICING TO QUALIFIED SERVICE PERSONNEL.</b>		
	THIS SYMBOL INDICATES THAT DANGEROUS VOLTAGE CONSTITUTING A RISK OF ELECTRIC SHOCK IS PRESENT WITHIN THIS UNIT.	
	THIS SYMBOL INDICATES THAT THERE ARE IMPORTANT OPERATING AND MAINTENANCE INSTRUCTIONS IN THE OWNER'S MANUAL WITH THIS UNIT.	

**NOTE:** This symbol and recycle system are applied only to EU countries and not applied to the countries in the other area of the world.



Your EIKI product is designed and manufactured with high quality materials and components which can be recycled and reused.

This symbol means that electrical and electronic equipment, at their end-of-life, should be disposed of separately from your household waste.

Please dispose of this equipment at your local community waste collection/recycling centre.

In the European Union there are separate collection systems for used electrical and electronic products.

Please help us to conserve the environment we live in!

**READ AND KEEP THIS OWNER'S MANUAL FOR LATER USE.**



## Safety Precaution

**WARNING: TO REDUCE THE RISK OF FIRE OR ELECTRIC SHOCK, DO NOT EXPOSE THIS APPLIANCE TO RAIN OR MOISTURE.**

- This projector produces intense light from the projection lens. Do not stare directly into the lens, otherwise eye damage could result. Be especially careful that children do not stare directly into the beam.
- Install the projector in a proper position. Otherwise it may result in fire hazard.
- Allowing the proper amount of space on the top, sides, and rear of the projector cabinet is critical for proper air circulation and cooling of the unit. The dimension shown here indicate the minimum space required. If the projector is to be built into a compartment or similarly enclosed, these minimum distances must be maintained.

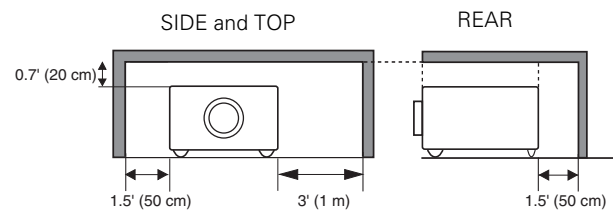

- Do not cover the ventilation slot on the projector. Heat build-up can reduce the service life of your projector, and can also be dangerous.
- If the projector is unused for an extended time, unplug the projector from the power outlet.



## CAUTION

**DO NOT SET THE PROJECTOR IN GREASY, WET, OR SMOKY CONDITIONS SUCH AS IN A KITCHEN TO PREVENT A BREAKDOWN OR A DISASTER. IF THE PROJECTOR COMES IN CONTACT WITH OIL OR CHEMICALS, IT MAY BECOME DETERIORATED.**

## CAUTION

Not for use in a computer room as defined in the Standard for the Protection of Electronic Computer/Data Processing Equipment, ANSI/NFPA 75.

Ne peut être utilisé dans une salle d'ordinateurs telle que définie dans la norme ANSI/NFPA 75 Standard for Protection of Electronic Computer/Data Processing Equipment

# Safety Instructions

All the safety and operating instructions should be read before the product is operated.

Read all of the instructions given here and retain them for later use. Unplug this projector from AC power supply before cleaning. Do not use liquid or aerosol cleaners. Use a damp cloth for cleaning.

Follow all warnings and instructions marked on the projector.

For added protection to the projector during a lightning storm, or when it is left unattended and unused for long periods of time, unplug it from the wall outlet. This will prevent damage due to lightning and power line surges.

---

Do not expose this unit to rain or use near water... for example, in a wet basement, near a swimming pool, etc...

Do not use attachments not recommended by the manufacturer as they may cause hazards.

Do not place this projector on an unstable cart, stand, or table. The projector may fall, causing serious injury to a child or adult, and serious damage to the projector. Use only with a cart or stand recommended by the manufacturer, or sold with the projector. Wall or shelf mounting should follow the manufacturer's instructions, and should use a mounting kit approved by the manufacturers.

An appliance and cart combination should be moved with care. Quick stops, excessive force, and uneven surfaces may cause the appliance and cart combination to overturn.



---

Slots and openings in the back and bottom of the cabinet are provided for ventilation, to ensure reliable operation of the equipment and to protect it from overheating.

The openings should never be covered with cloth or other materials, and the bottom opening should not be blocked by placing the projector on a bed, sofa, rug, or other similar surface. This projector should never be placed near or over a radiator or heat register.

This projector should not be placed in a built-in installation such as a book case unless proper ventilation is provided.

Never push objects of any kind into this projector through cabinet slots as they may touch dangerous voltage points or short out parts that could result in a fire or electric shock. Never spill liquid of any kind on the projector.

Do not install the projector near the ventilation duct of air-conditioning equipment.

This projector should be operated only from the type of power source indicated on the marking label. If you are not sure of the type of power supplied, consult your authorized dealer or local power company.

Do not overload wall outlets and extension cords as this can result in fire or electric shock. Do not allow anything to rest on the power cord. Do not locate this projector where the cord may be damaged by persons walking on it.

Do not attempt to service this projector yourself as opening or removing covers may expose you to dangerous voltage or other hazards. Refer all servicing to qualified service personnel.

Unplug this projector from wall outlet and refer servicing to qualified service personnel under the following conditions:

- a. When the power cord or plug is damaged or frayed.
- b. If liquid has been spilled into the projector.
- c. If the projector has been exposed to rain or water.
- d. If the projector does not operate normally by following the operating instructions. Adjust only those controls that are covered by the operating instructions as improper adjustment of other controls may result in damage and will often require extensive work by a qualified technician to restore the projector to normal operation.
- e. If the projector has been dropped or the cabinet has been damaged.
- f. When the projector exhibits a distinct change in performance-this indicates a need for service.

When replacement parts are required, be sure the service technician has used replacement parts specified by the manufacturer that have the same characteristics as the original part. Unauthorized substitutions may result in fire, electric shock, or injury to persons.

Upon completion of any service or repairs to this projector, ask the service technician to perform routine safety checks to determine that the projector is in safe operating condition.



## Voor de klanten in Nederland

Bij dit produkt zijn batterijen geleverd.

Wanneer deze leeg zijn, moet u ze niet weggooien maar inleveren als KCA.



## Air Circulation

Openings in the cabinet are provided for ventilation. To ensure reliable operation of the product and to protect it from overheating, these openings must not be blocked or covered.



### CAUTION

Hot air is exhausted from the exhaust vent. When using or installing the projector, the following precautions should be taken.

- Do not put any flammable object or spray can near the projector, hot air is exhausted from the air vents.
- Keep the exhaust vent at least 3' (1 m) away from any objects.
- Do not touch a peripheral part of the exhaust vent, especially screws and metallic parts. These areas will become hot while the projector is being used.
- Do not put anything on the cabinet. Objects put on the cabinet will not only get damaged but also may cause fire hazard by heat.

Cooling fans are provided to cool down the projector. The fans' running speed is changed according to the temperature inside the projector.

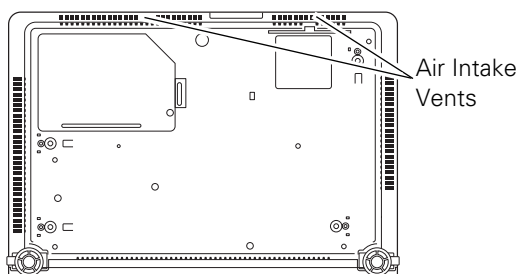
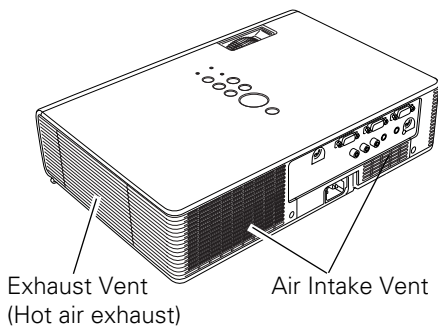
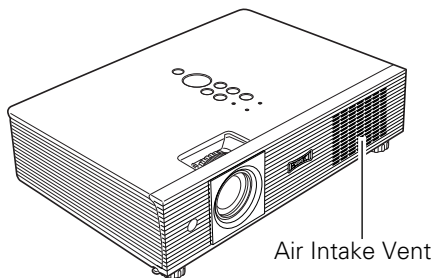

## Moving the Projector

When moving the projector, close the slide shutter and retract adjustable feet to prevent damage to the lens and cabinet.

When the projector is not in use for an extended period, put it into a suitable case to protect the projector.



### CAUTION IN CARRYING OR TRANSPORTING THE PROJECTOR

- Do not drop or bump the projector, otherwise damages or malfunctions may result.
- When carrying the projector, use a suitable carrying case.
- Do not transport the projector by courier or any other transport service in an unsuitable transport case. This may cause damage to the projector. For information about transporting the projector by courier or any other transport service, consult your dealer.
- Do not put the projector in a case before the projector is cooled enough.

## Installing the Projector in Proper Directions

Use the projector properly in specified positions. Improper positioning may reduce the lamp life and result in severe accident or fire hazard.

This projector can project the picture upward, downward, or backward, perpendicular to the plane of the screen as shown in the figure below.

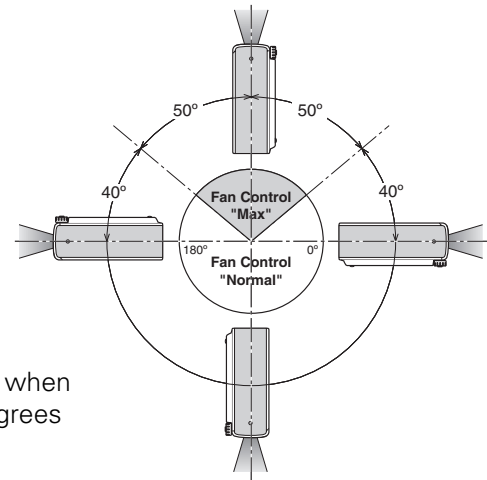
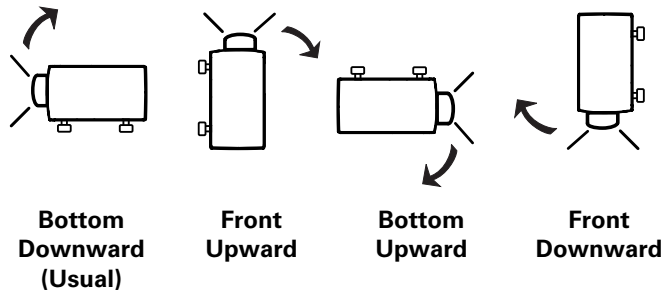

Be sure to set the Fan control in MAX in the setting menu when the projector is inclined between +40 degrees to +140 degrees to the horizontal plane (p.49).

## Positioning Precautions

Avoid positioning the projector as described below when installing.

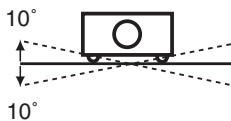

Do not tilt the projector more than 10 degrees from side to side.



Do not put the projector on either side to project an image.

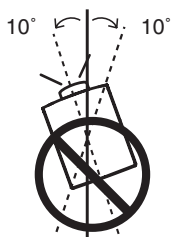

In upward projection, do not tilt the projector over 10 degrees right and left.

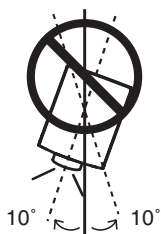

In downward projection, do not tilt the projector over 10 degrees right and left.

## Federal Communications Commission Notice

This equipment has been tested and found to comply with the limits for a Class B digital device, pursuant to Part 15 of the FCC Rules. These limits are designed to provide reasonable protection against harmful interference in a residential installation. This equipment generates, uses, and can radiate radio frequency energy and, if not installed and used in accordance with the instructions, may cause harmful interference to radio communications. However, there is no guarantee that interference will not occur in a particular installation. If this equipment does cause harmful interference to radio or television reception, which can be determined by turning the equipment off and on, the user is encouraged to try to correct the interference by one or more of the following measures:

- Reorient or relocate the receiving antenna.
- Increase the separation between the equipment and receiver.
- Connect the equipment into an outlet on a circuit different from that to which the receiver is connected.
- Consult the dealer or an experienced radio/TV technician for help.

Use of shielded cable is required to comply with class B limits in Subpart B of Part 15 of FCC Rules.

Do not make any changes or modifications to the equipment unless otherwise specified in the instructions. If such changes or modifications should be made, you could be required to stop operation of the equipment.

Model Number(s) : LC-XB41  
Trade Name : EIKI  
Responsible party : EIKI International, Inc.  
Address : 30251 Esperanza Rancho Santa Margarita CA 92688-2132, U.S.A.  
Telephone No. : 800-242-3454 (949-457-0200)

## AC Power Cord Requirement

The AC Power Cord supplied with this projector meets the requirement for use in the country you purchased it.

### AC Power Cord for the United States and Canada:

AC Power Cord used in the United States and Canada is listed by the Underwriters Laboratories (UL) and certified by the Canadian Standard Association (CSA).

AC Power Cord has a grounding-type AC line plug. This is a safety feature to be sure that the plug will fit into the power outlet. Do not try to defeat this safety feature. Should you be unable to insert the plug into the outlet, contact your electrician.



### AC Power Cord for the United Kingdom:

This cord is already fitted with a moulded plug incorporating a fuse, the value of which is indicated on the pin face of the plug. Should the fuse need to be replaced, an ASTA approved BS 1362 fuse must be used of the same rating, marked thus  $\diamond$ . If the fuse cover is detachable, never use the plug with the cover omitted. If a replacement fuse cover is required, ensure it is of the same colour as that visible on the pin face of the plug (i.e. red or orange). Fuse covers are available from the Parts Department indicated in your User Instructions. If the plug supplied is not suitable for your socket outlet, it should be cut off and destroyed. The end of the flexible cord should be suitably prepared and the correct plug fitted.

**WARNING: A PLUG WITH BARED FLEXIBLE CORD IS HAZARDOUS IF ENGAGED IN A LIVE SOCKET OUTLET.**

The Wires in this mains lead are coloured in accordance with the following code:

Green-and-yellow ..... Earth  
Blue ..... Neutral  
Brown ..... Live

As the colours of the wires in the mains lead of this apparatus may not correspond with the coloured markings identifying the terminals in your plug proceed as follows:

The wire which is coloured green-and-yellow must be connected to the terminal in the plug which is marked by the letter E or by the safety earth symbol  $\perp$  or coloured green or green-and-yellow.

The wire which is coloured blue must be connected to the terminal which is marked with the letter N or coloured black.

The wire which is coloured brown must be connected to the terminal which is marked with the letter L or coloured red.

**WARNING: THIS APPARATUS MUST BE EARTHED.**

**THE SOCKET-OUTLET SHOULD BE INSTALLED NEAR THE EQUIPMENT AND EASILY ACCESSIBLE.**



# Part Names and Functions

## Front

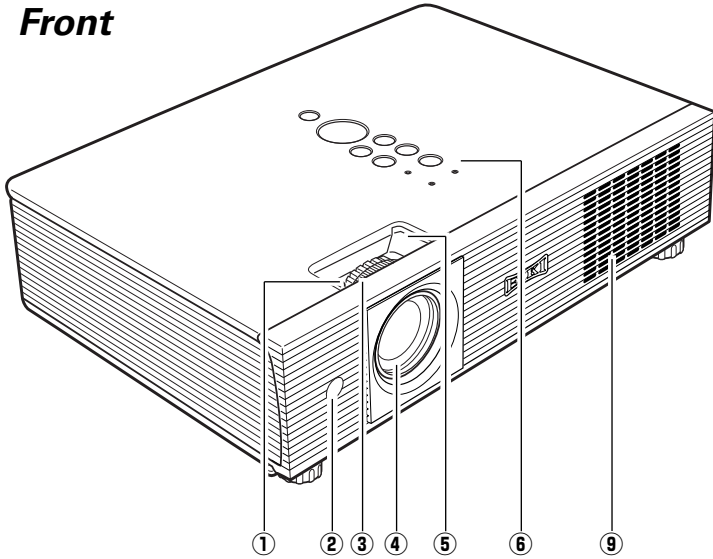

- ① Zoom Ring
- ② Infrared Remote Receiver
- ③ Focus Ring
- ④ Projection Lens
- ⑤ Slide Shutter Lever
- ⑥ Top Controls and Indicators
- ⑦ Exhaust Vent



### CAUTION

Hot air is exhausted from the exhaust vents. Do not put heat-sensitive objects near this side.

- ⑧ Speaker
- ⑨ Air Intake Vents
- ⑩ Terminals and Connectors
- ⑪ Power Cord Connector
- ⑫ Lamp Cover
- ⑬ Filter
- ⑭ Adjustable Feet

## Back

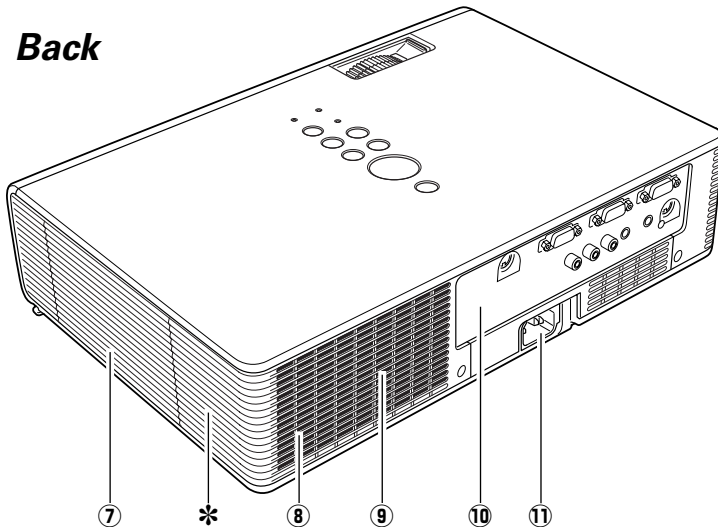

### \* Kensington Security Slot

This slot is for a Kensington lock used to deter theft of the projector.

\* Kensington is a registered trademark of ACCO Brands Corporation.

## Bottom

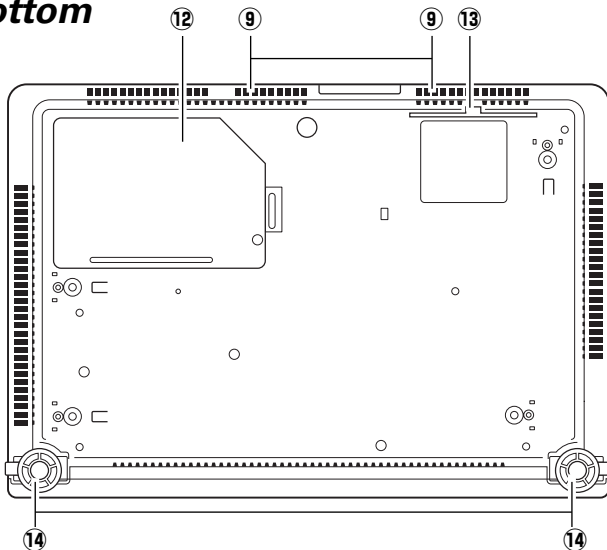

## Rear Terminal

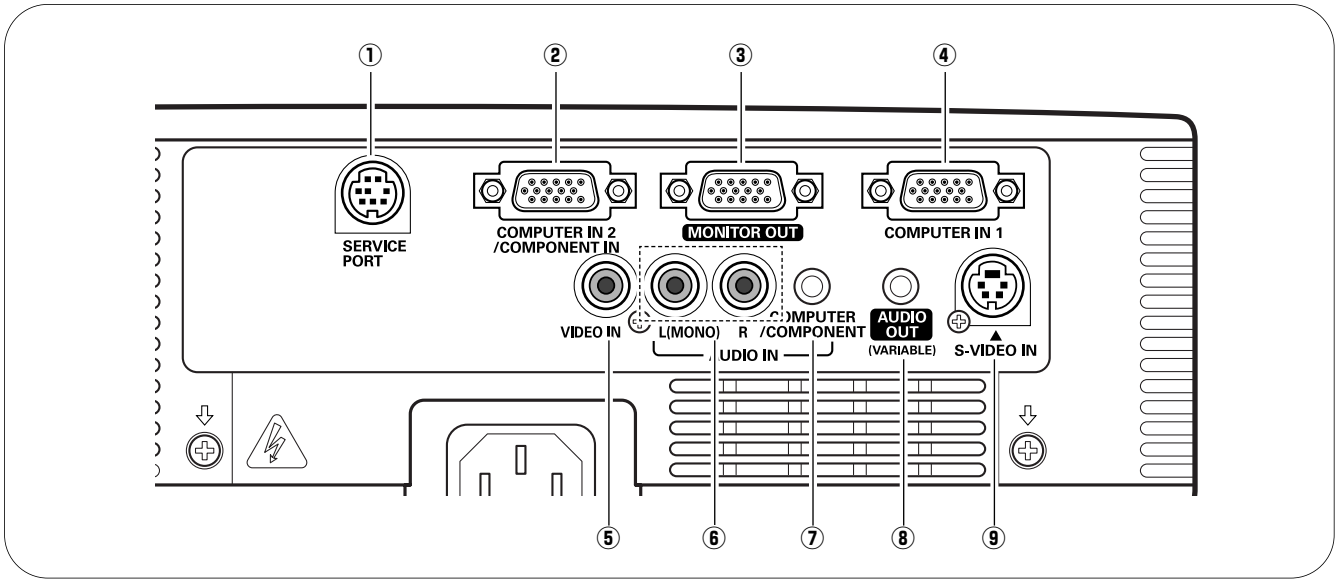

**① SERVICE PORT**

This jack is used to service the projector.

**② COMPUTER IN 2 / COMPONENT IN**

Connect the computer or component video (or RGB Scart) output signal to this terminal. Use the supplied VGA cable or a Component-VGA cable (not supplied).

**③ MONITOR OUT**

This terminal can be used to output the incoming signal from COMPUTER IN 1 terminal or COMPUTER IN 2 / COMPONENT IN terminal to the other monitor (pp.15, 17).

**④ COMPUTER IN 1**

Connect the computer output to this terminal (p.15).

**⑤ VIDEO IN**

Connect the composite video output signal to this jack (p.16).

**⑥ AUDIO IN**

Connect the audio output signal from video equipment connected to ⑤ or ⑨ to this jack. For a mono audio signal (a single audio jack), connect it to the L (MONO) jack (p.16).

**⑦ COMPUTER / COMPONENT AUDIO IN**

Connect the audio output (stereo) signal from a computer or video equipment connected to ② or ④ to this jack (pp.15, 17).

**⑧ AUDIO OUT (VARIABLE)**

Connect an external audio amplifier to this jack (pp.15–17). This terminal outputs sound from AUDIO IN terminal (⑥ or ⑦).

**⑨ S-VIDEO IN**

Connect the S-VIDEO output signal from video equipment to this jack (p.16).

**Top Control**

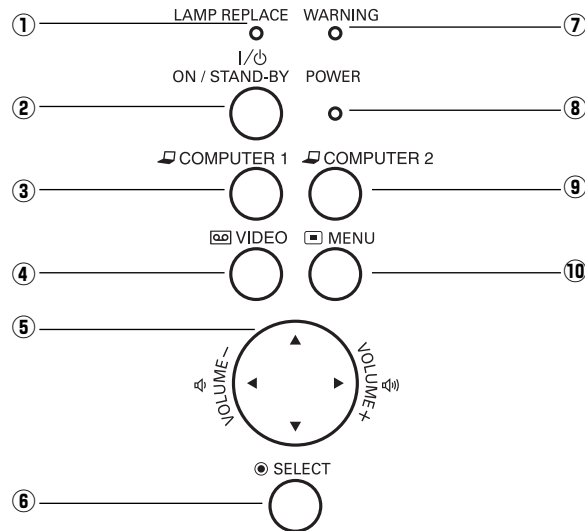

- ① LAMP REPLACE indicator**  
 Lights yellow when the projection lamp reaches its end of life (pp.54, 60).
- ② ON/STAND-BY button**  
 Turn the projector on or off (pp.19, 20).
- ③ COMPUTER 1 button**  
 Select COMPUTER 1 input source (p.26).
- ④ VIDEO button**  
 Select VIDEO input source (p.35).
- ⑤ POINT ▲▼◀▶ (VOLUME +/-) buttons**  
 –Select an item or adjust the value in the On-Screen Menu (p.21).  
 –Pan the image in the Digital zoom + mode (p.34).  
 –Adjust the volume level (Point ◀▶ buttons) (p.23).
- ⑥ SELECT button**  
 –Execute the selected item (p.21).  
 –Expand or compress the image in the Digital zoom mode (p.34).
- ⑦ WARNING indicator**  
 –Lights red when the projector detects an abnormal condition.  
 –Blinks red when the internal temperature of the projector exceeds the operating range (pp.51, 60).
- ⑧ POWER indicator**  
 –Lights red when the projector is in stand-by mode.  
 –Lights green during operations.  
 –Blinks green in the Power management mode (pp.46, 60).
- ⑨ COMPUTER 2 button**  
 Select COMPUTER 2 input source (pp.26, 36).
- ⑩ MENU button**  
 Open or close the On-Screen Menu (p.21).

## Remote Control

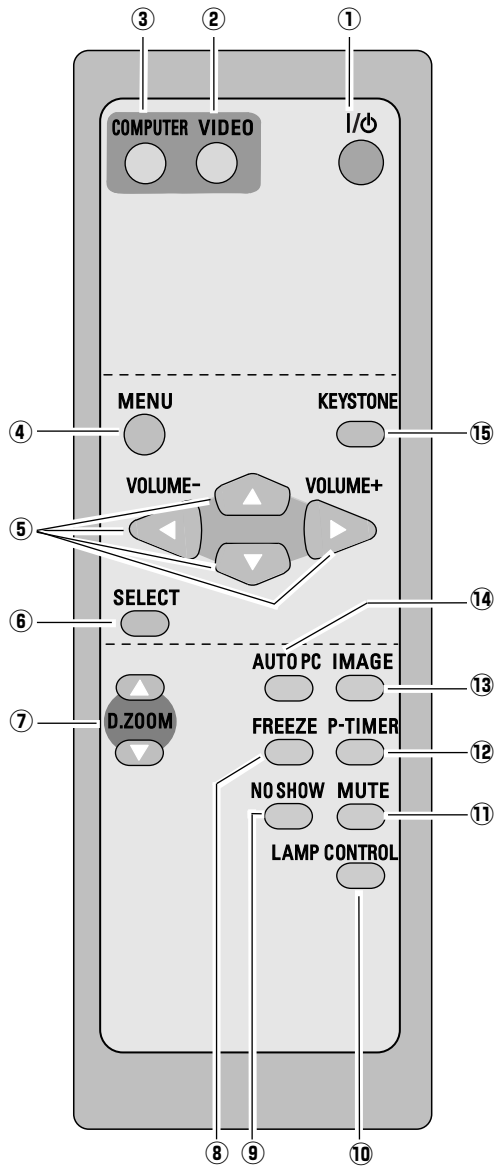

- ① **ON/STAND-BY button**  
Turn the projector on or off. (pp.19, 20)
- ② **VIDEO button**  
Select VIDEO input source. (pp.24, 35)
- ③ **COMPUTER button**  
Select COMPUTER input source. (pp.24, 26, 36)
- ④ **MENU button**  
Open or close the On-Screen Menu. (p.21)
- ⑤ **Point ▲▼◀▶ ( VOLUME + / - ) buttons**
  - Select an item or adjust the value in the On-Screen Menu. (p.21)
  - Pan the image in Digital zoom + mode. (p.34)
  - Adjust the volume level. (Point ◀▶ buttons) (p.23)
- ⑥ **SELECT button**
  - Execute the selected item. (p.21)
  - Expand or compress the image in Digital zoom mode. (p.34)
- ⑦ **D.ZOOM ▲▼ buttons**  
Zoom in and out the images. (pp.25, 34)
- ⑧ **FREEZE button**  
Freeze the picture. (p.24)
- ⑨ **NO SHOW button**  
Temporarily turn off the image on the screen. (p.25)
- ⑩ **LAMP CONTROL button**  
Select the lamp mode. (pp.25, 46)
- ⑪ **MUTE button**  
Mute the sound. (p.23)
- ⑫ **P-TIMER button**  
Operate the P-timer function. (p.25)
- ⑬ **IMAGE button**  
Select the image mode. (pp.25, 31, 38)
- ⑭ **AUTO PC button**  
Automatically adjust the computer image to its optimum setting. (pp.25, 28)
- ⑮ **KEYSTONE button**  
Correct the keystone distortion. (pp.24, 42)



To ensure safe operation, please observe the following precautions :

- Do not bend, drop the remote control or expose the remote control to moisture or heat.
- For cleaning, use soft dry cloth. Do not apply benzene, thinner, spray or any chemical material.

## Remote Control Battery Installation

- 1** Open the battery compartment lid.

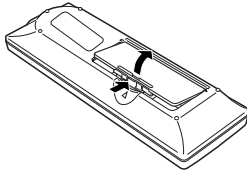

- 2** Install new batteries into the compartment.

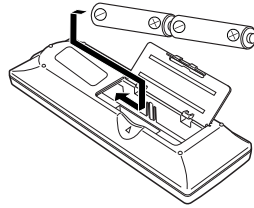

**Two AA size batteries**

For correct polarity (+ and -), be sure battery terminals are in contact with pins in the compartment.

- 3** Replace the compartment lid.

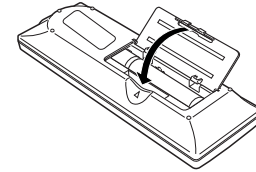

To insure safe operation, please observe the following precautions:

- Use two (2) AA or LR6 type alkaline batteries.
- Always replace batteries in sets.
- Do not use a new battery with a used battery.
- Avoid contact with water or liquid.
- Do not expose the remote control to moisture or heat.
- Do not drop the remote control.
- If the battery has leaked on the remote control, carefully wipe the case clean and install new batteries.
- Risk of explosion if a battery is replaced by an incorrect type.
- Dispose of used batteries according to the instructions.

## Remote Control Operating Range

Point the remote control toward the projector (Infrared Remote Receiver) when pressing the buttons. Maximum operating range for the remote control is about 16.4' (5 m) and 60 degrees in front of the projector.

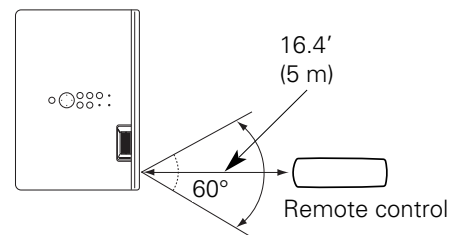

# Installation

## Positioning the Projector

For projector positioning, see the figures below. The projector should be set perpendicularly to the plane of the screen.

**✓Notes:**

- The brightness in the room has a great influence on picture quality. It is recommended to limit ambient lighting in order to obtain the best image.
- All measurements are approximate and may vary from the actual sizes.

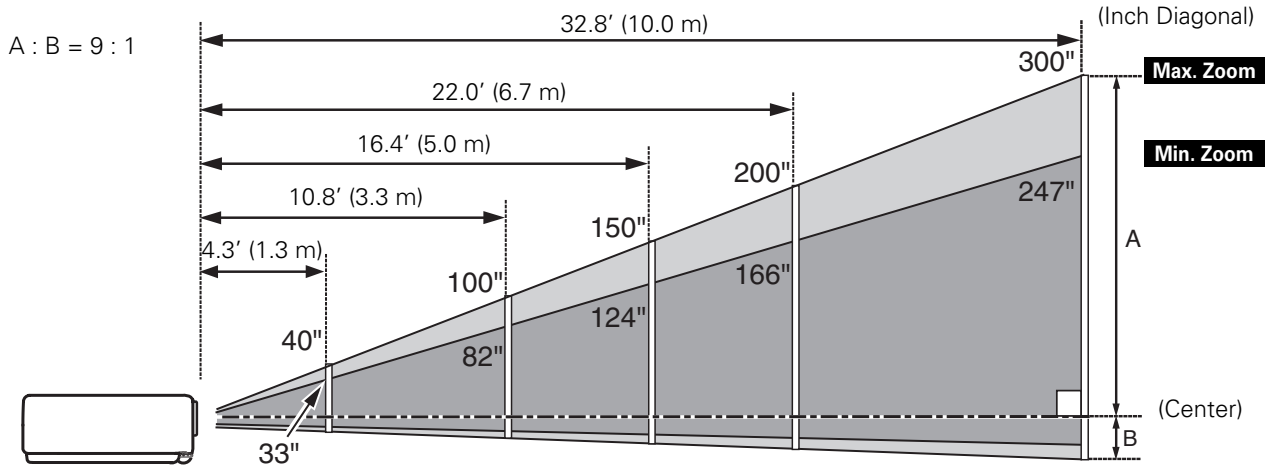

Screen Size (W x H) mm	33"	40"	100"	150"	200"	300"
4 : 3 aspect ratio	671 x 503	813 x 610	2032 x 1524	3048 x 2286	4064 x 3048	6096 x 4572
Zoom (min)	4.3' (1.3 m)	5.2' (1.6 m)	13.1' (4.0 m)	20.0' (6.1 m)	26.6' (8.1 m)	—
Zoom (max)	—	4.3' (1.3 m)	10.8' (3.3 m)	16.4' (5.0 m)	22.0' (6.7 m)	32.8' (10.0 m)

## Adjustable Feet

Projection angle can be adjusted up to approx. 9 degrees with the adjustable feet.

Lift the front of the projector and pull the feet lock latches on both side of the projector upward.

Release the feet lock latches to lock the adjustable feet and rotate the adjustable feet to a proper height, and tilt.

Keystone distortion can be adjusted manually by using the remote control or the menu operation (see pages 24, 42).

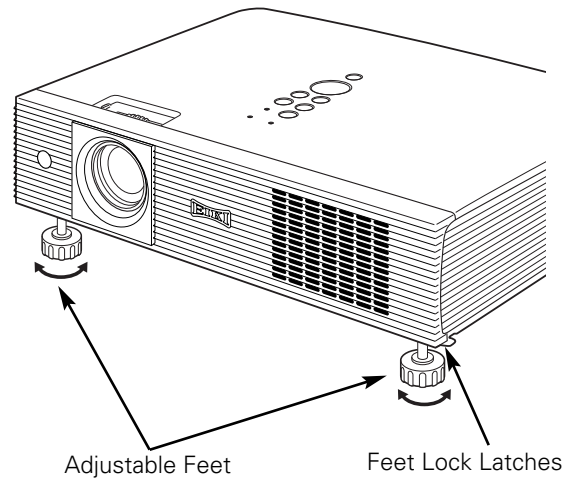

## Connecting to a Computer

### Cables used for connection

- VGA Cable (Mini D-sub 15 pin)\*
- Audio Cables

(\*One cable is supplied; other cables are not supplied with the projector.)

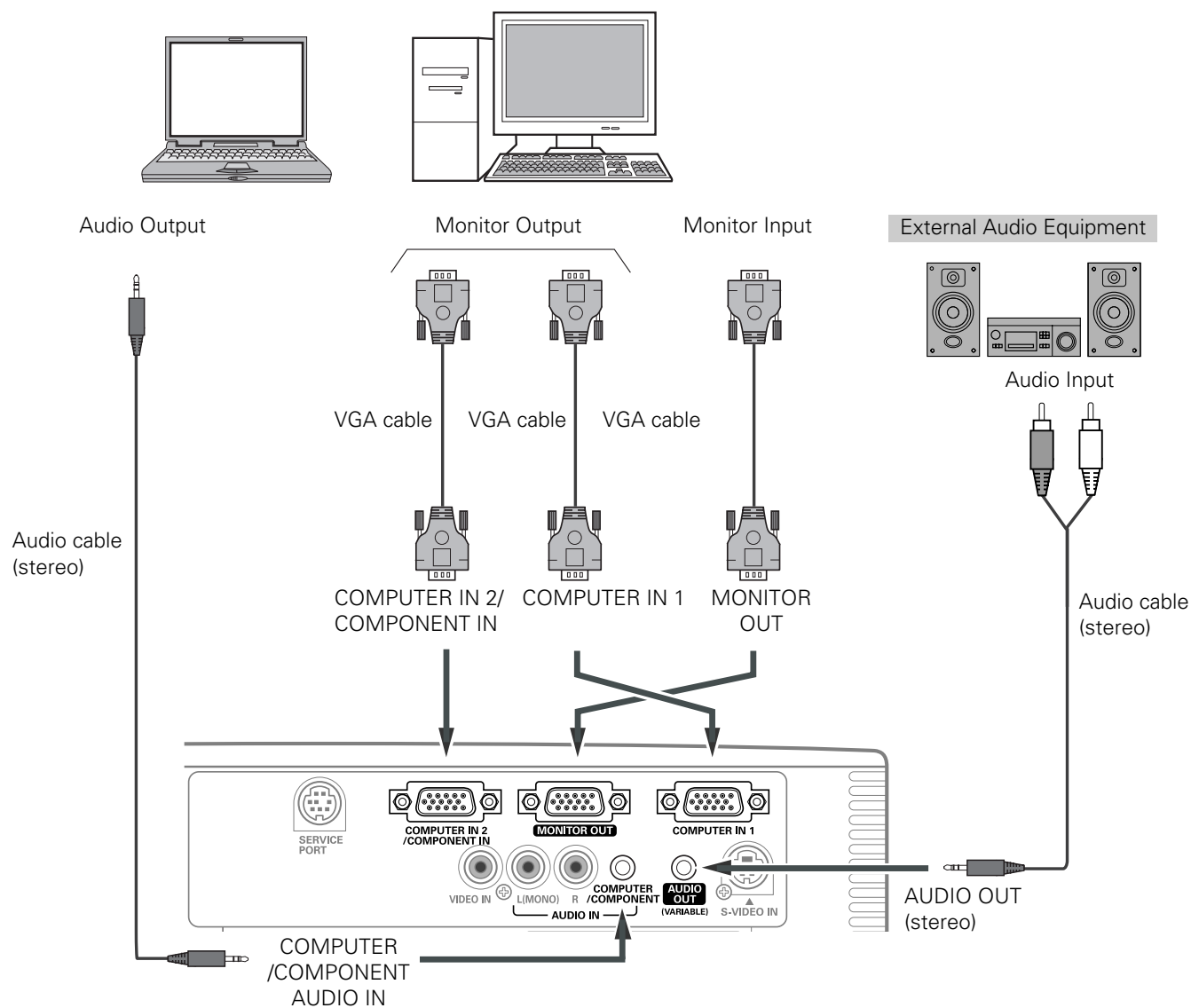

### ✓Notes:

- Input sound to the COMPUTER/COMPONENT AUDIO IN terminal when using the COMPUTER IN 1 and the COMPUTER IN 2 / COMPONENT IN terminal as input.
- When connecting the AUDIO OUT to external audio equipment, the projector's built-in speaker is disconnected.



Unplug the power cords of both the projector and external equipment from the AC outlet before connecting cables.

## Connecting to Video Equipment

### Cables used for connection

- Video and Audio Cable (RCA x 3)
  - S-VIDEO Cable
  - Audio Cable
- (Cables are not supplied with the projector.)

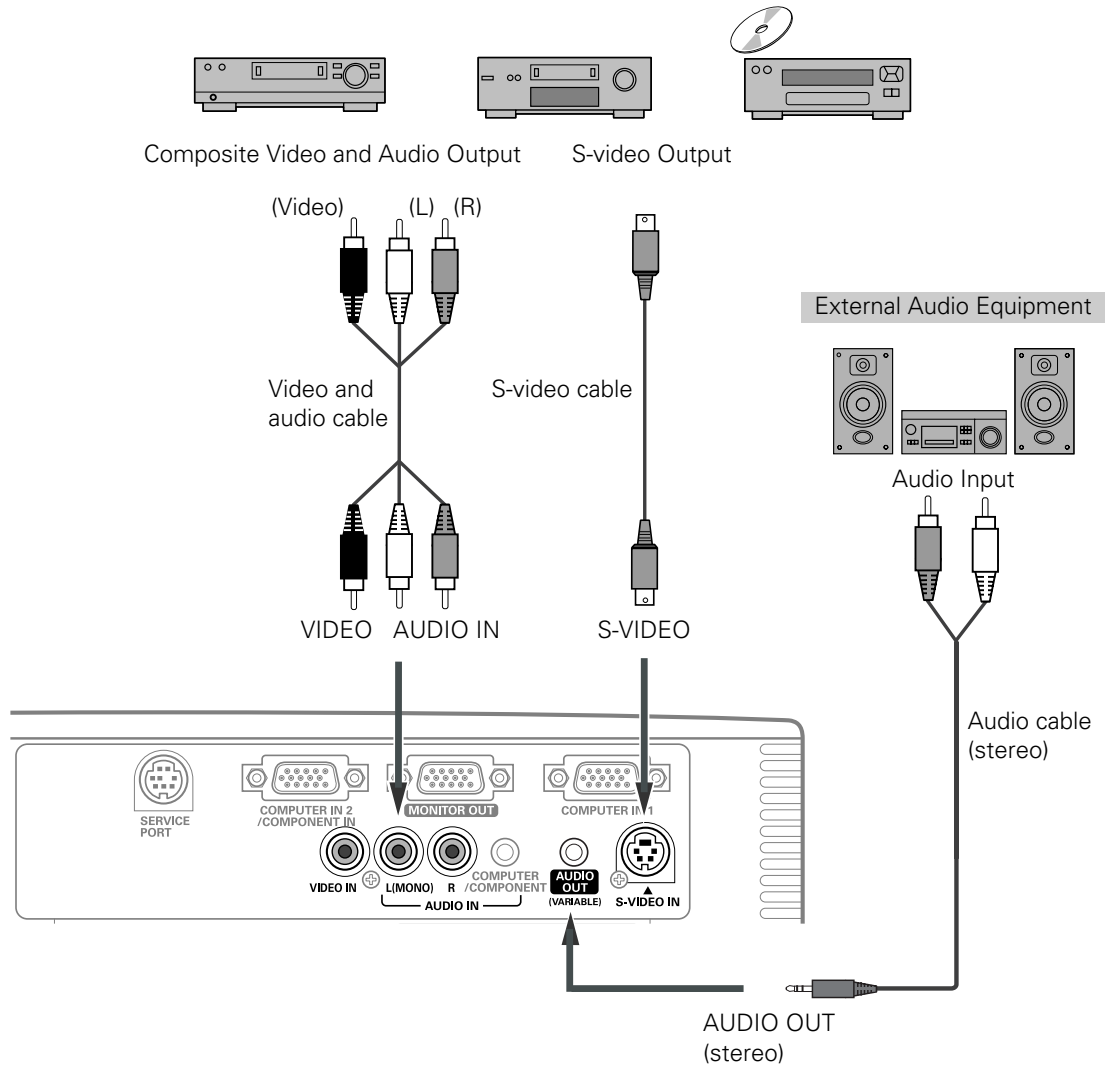

### ✓Notes:

- When connecting the AUDIO OUT to external audio equipment, the projector's built-in speaker is disconnected.
- The S-VIDEO jack connection overrides the VIDEO jack connection when selecting AUTO in the Input Menu (p.35).



Unplug the power cords of both the projector and external equipment from the AC outlet before connecting cables.



## Connecting to Component Video Equipment

### Cables used for connection

- Audio Cables
- Scart-VGA Cable
- Component Cable
- Component-VGA Cable

(Cables are not supplied with the projector.)

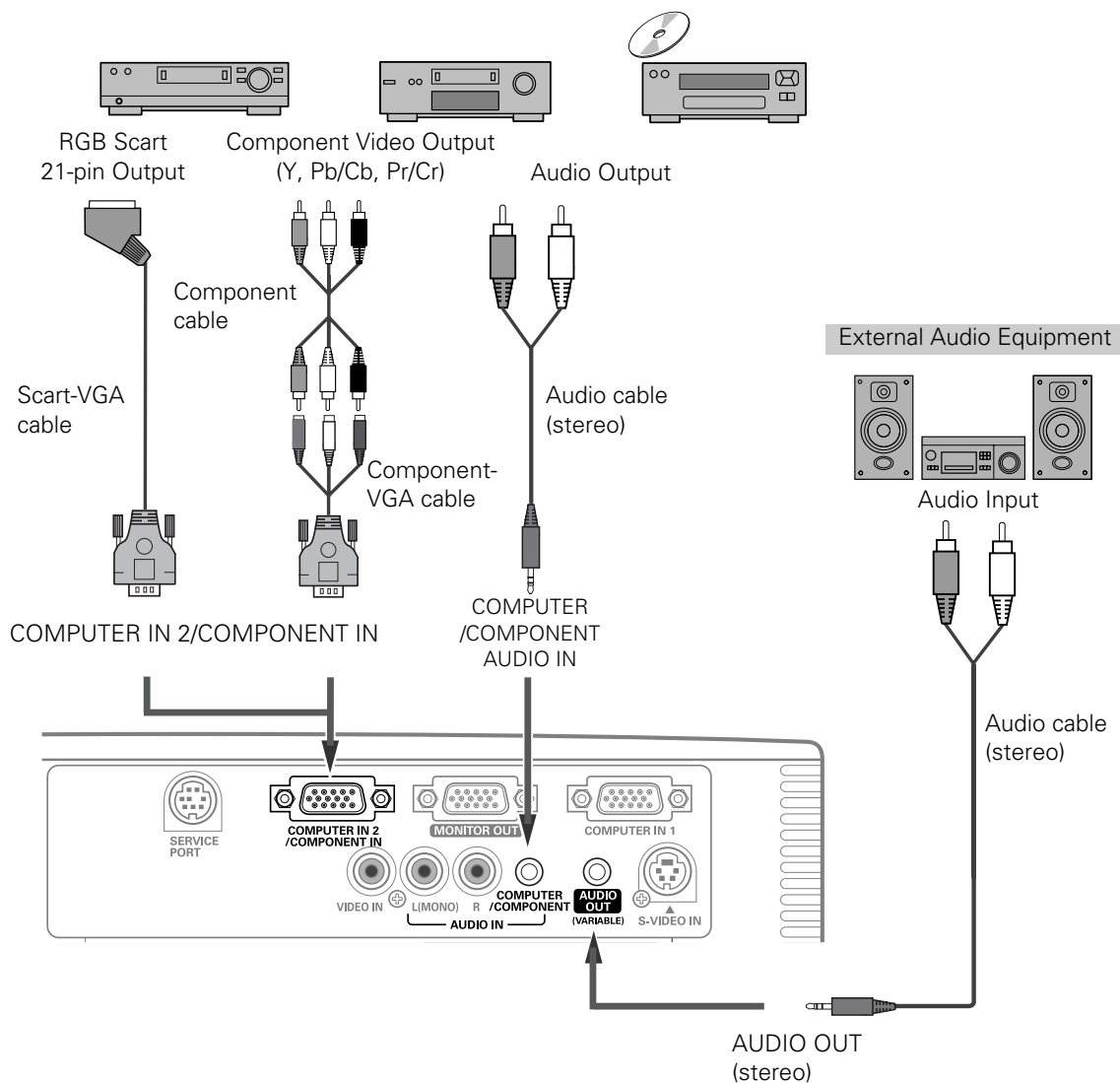

### ✓Notes:

- When connecting the AUDIO OUT to external audio equipment, the projector's built-in speaker is disconnected.
- See page 63 for ordering optional cables.
- RGB Scart signal cannot be output from the MONITOR OUT terminal.



Unplug the power cords of both the projector and external equipment from the AC outlet before connecting cables.

**Connecting the AC Power Cord**

This projector uses nominal input voltages of 100–120 V or 200–240 V AC and it automatically selects the correct input voltage. It is designed to work with single-phase power systems having a grounded neutral conductor. To reduce the risk of electrical shock, do not plug into any other type of power system.

If you are not sure of the type of power being supplied, consult your authorized dealer or service station. Connect the projector with all peripheral equipment before turning the projector on.

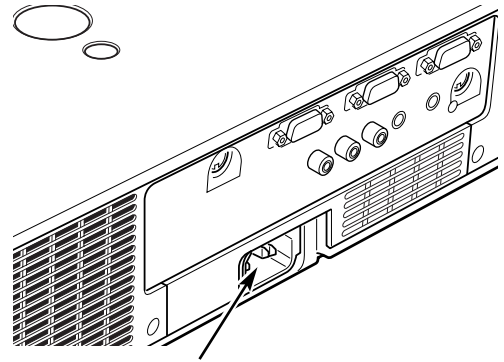

Connect the AC power cord (supplied) to the projector. The AC outlet must be near this equipment and must be easily accessible.

**CAUTION**

For safety, unplug the AC power cord when the projector is not in use. When the projector is connected to an outlet with the AC power cord, it is in stand-by mode and consumes a little electric power.

**NOTE ON THE POWER CORD**

AC power cord must meet the requirements of the country where you use the projector. Confirm the AC plug type with the chart below and proper AC power cord must be used. If supplied the AC power cord does not match your AC outlet, contact your sales dealer.

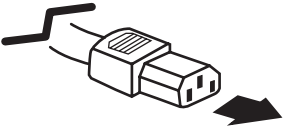
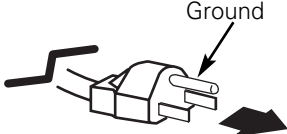
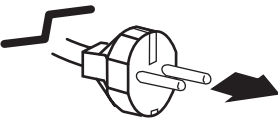
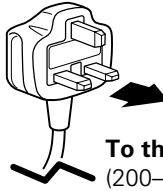
Projector side	AC outlet side		
 <p>To power cord connector on your projector.</p>	<p><b>For the U.S.A. and Canada</b></p>  <p>To the AC outlet. (120 V AC)</p>	<p><b>For Continental Europe</b></p>  <p>To the AC outlet. (200–240 V AC)</p>	<p><b>For the U.K.</b></p>  <p>To the AC outlet. (200–240 V AC)</p>

# Basic Operation

## Turning On the Projector

- 1 Complete peripheral connections (with a computer, VCR, etc.) before turning on the projector.
- 2 Connect the projector's AC power cord into an AC outlet. The POWER indicator lights red. Open the slide shutter by sliding the slide shutter lever. (see page 53)
- 3 Press the ON/STAND-BY button on the top control or the remote control. The POWER indicator lights green and the cooling fans start to operate. The preparation display appears on the screen and the count down starts.
- 4 After the countdown, the input source that was selected the last time and the lamp control status icon (see page 46) appear on the screen.

If the projector is locked with a PIN code, PIN code input dialog box will appear. Enter the PIN code as instructed below.

### Enter a PIN code

Use the Point ▲▼ buttons to enter a number. Press the Point ► button to fix the number and move the red frame pointer to the next box. The number changes to "\*." If you fixed an incorrect number, use the Point ◀ button to move the pointer to the number you want to correct, and then enter the correct number.

Repeat this step to complete entering a four-digit number.

After entering the four-digit number, move the pointer to "Set." Press the SELECT button so that you can start to operate the projector.

If you entered an incorrect PIN code, "PIN code" and the number (\*\*\*\*) will turn red for a moment. Enter the correct PIN code all over again.

### What is PIN code?

PIN (Personal Identification Number) code is a security code that allows the person who knows it to operate the projector. Setting a PIN code prevents unauthorized use of the projector.

A PIN code consists of a four-digit number. Refer to the PIN code lock function in the Setting Menu on page 48 for locking operation of the projector with your PIN code.



#### CAUTION ON HANDLING PIN CODE

If you forget your PIN code, the projector can no longer be started. Take a special care in setting a new PIN code; write down the number in a column on page 65 of this manual and keep it at hand. Should the PIN code be missing or forgotten, consult your dealer or service center.



The preparation display will disappear after 30 seconds.

### Selected Input Source and Lamp Control



(See page 46 for Lamp control status.)

#### ✓ Note:

- The Filter warning and Lamp replacement icons may appear on the screen depending on the usage state of the projector.

### PIN Code Input Dialog Box

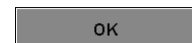
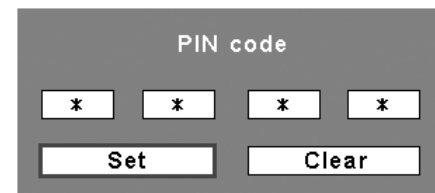

After the OK icon disappears, you can operate the projector.

#### ✓ Notes:

- When the Logo select function is set to "Off," the logo will not be shown on the screen (p.43).
- When the "Countdown off" or "Off" is selected in the Display function, the countdown will not be shown on the screen (p.42).
- During the countdown period, all operations are invalid.
- If the correct PIN code number is not entered within three minutes after the PIN code dialog box appeared, the projector will be turned off automatically.
- The "1234" is set as the initial PIN code at the factory.
- When the Input Search function is set to "On2", the input signal will be searched automatically (p.45)

### Turning Off the Projector

- 1** Press the ON/STAND-BY button on the top control or on the remote control, and "Power off?" appears on the screen.
- 2** Press the ON/STAND-BY button again to turn off the projector. The POWER indicator starts to blink red, and the cooling fans keep running. (You can select the level of fans' quietness and speed. See "Fan" on page 49.) At this time, you can unplug the AC power cord even if the fans are still running.
- 3** When the projector has cooled down enough, the POWER indicator stops blinking and you can turn on the projector. After it is cooled down completely, unplug the AC power cord.

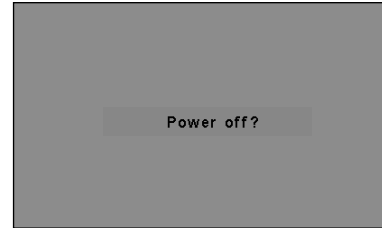

The message will disappear after 4 seconds.



TO MAINTAIN THE LIFE OF THE LAMP, ONCE YOU TURN THE PROJECTOR ON, WAIT AT LEAST FIVE MINUTES BEFORE TURNING IT OFF.

#### ✓Notes:

- When the On start function is set to "On," the projector will be turned on automatically by connecting the AC power cord to an AC outlet (p.46).
- DO NOT OPERATE THE PROJECTOR CONTINUOUSLY WITHOUT REST. CONTINUOUS USE MAY RESULT IN SHORTENING THE LAMP LIFE. TURN OFF THE PROJECTOR AND LET STAND FOR ABOUT AN HOUR IN EVERY 24 HOURS.
- The running speed of cooling fans is changed according to the temperature inside the projector.
- Do not put the projector in a case before the projector is cooled enough.
- If the WARNING indicator blinks or lights red, see "Warning Indicator" on page 51.
- While the POWER indicator is blinking, the lamp is being cooled down and the projector cannot be turned on. Wait until the POWER indicator stops blinking to turn on the projector again.
- The fan rotation will terminate directly if the AC power cord is unplugged immediately after the projector is turned off.
- The projector can be turned on after the POWER indicator turns red. The waiting time to restart will be shortened when the normal power-off processing for fan cooling is completed, compared with the time the AC power cord is immediately unplugged after the power-off.

## How to Operate the On-Screen Menu

The projector can be adjusted or set via the On-Screen Menu. For each adjustment and setting procedure, refer to the respective sections in this manual.

- 1 Press the MENU button on the top control or the remote control to display the On-Screen Menu.
- 2 Use the Point ◀▶ buttons to select a Menu icon. Use the Point ▲▼ buttons to select an item in the selected menu.
- 3 Press the SELECT button to show the item data. Use the Point ◀▶ buttons to adjust the values.

To close the On-Screen Menu, press the MENU button again.

**✓Note:**

- The selected item is not active until the SELECT button is pressed.

### Top Control

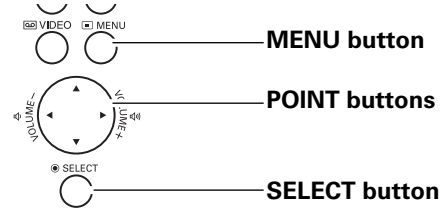

### Remote Control

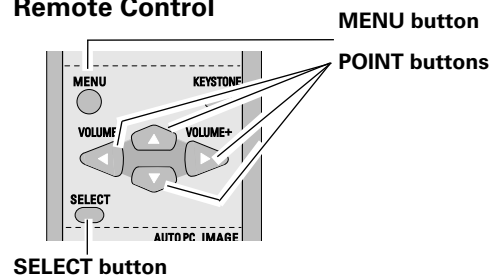

### On-Screen Menu

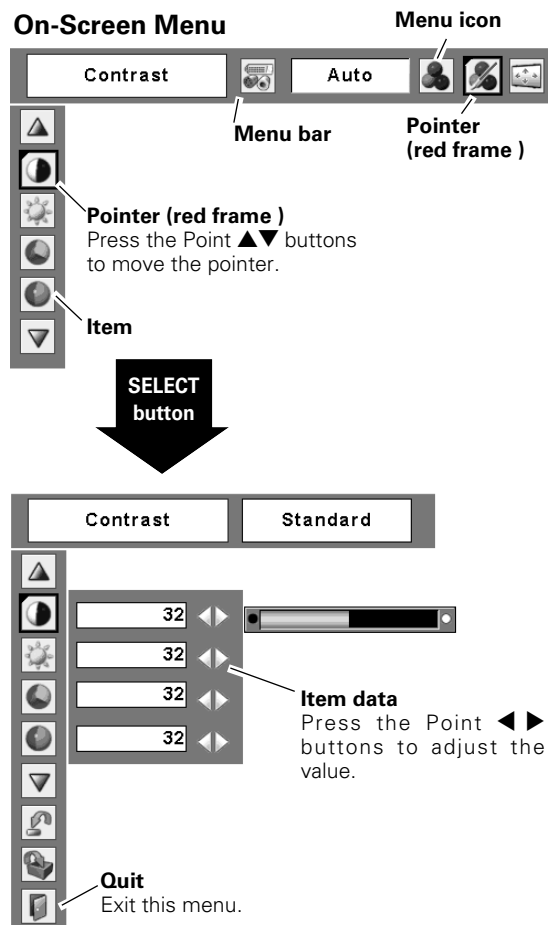

## Menu Bar

For detailed functions, see Menu Tree on pp.58, 59.

### For computer source

**Guide Window**

Show the selected Menu of the On-Screen Menu.

**PC System Menu**

Used to select computer system. (p.27)

**Image Select Menu**

Used to select an image mode among Dynamic, Standard, Real, Blackboard(Green), and Image 1 ~ 4. (p.31)

**Screen Menu**

Used to adjust size of image. [Normal / True / Wide / Full screen / Custom / Digital zoom +/-] (pp.33, 34)

**Setting Menu**

Used to set the projector's operating configurations. (pp.42-50)

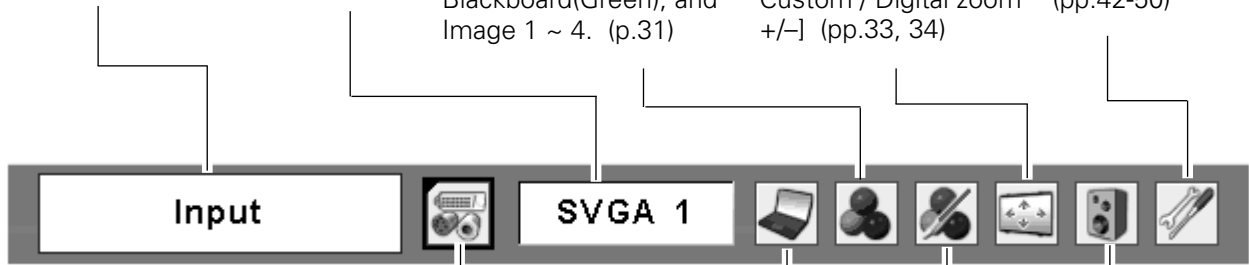

**Input Menu**

Used to select input source either Computer or Video. (p.26)

**PC Adjust Menu**

Used to adjust parameters to match with input signal format. (pp.28-30)

**Image Adjust Menu**

Used to adjust computer image. [Contrast / Brightness / Color temp. / White balance (R/G/B) / Sharpness / Gamma] (pp.32, 33)

**Sound Menu**

Used to adjust the volume or mute the sound. (p.23)

### For video source

**Input Menu**

Used to select input source either Video or Computer. (pp.35, 36)

**Image Select Menu**

Used to select an image mode among Dynamic, Standard, Cinema, Blackboard(Green) and Image 1 ~ 4. (p.38)

**Screen Menu**

Used to set size of image to Normal / Wide / Custom . (p.41)

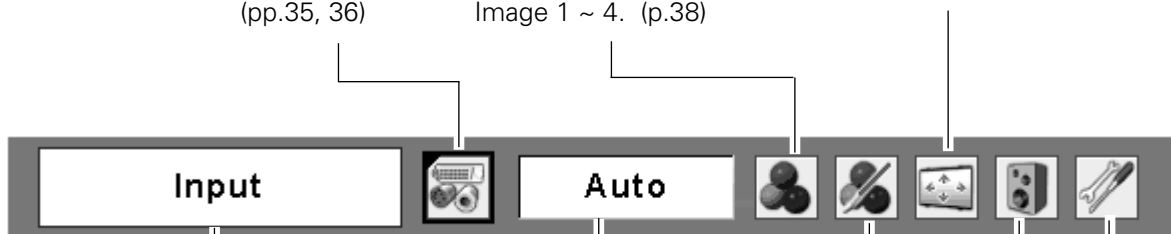

Same function as menu for computer source.

**AV System Menu**

Used to select system of selected video source. (p.37)

**Image Adjust Menu**

Used to adjust picture image. [Contrast / Brightness / Color / Tint / Color temp. / White balance (R/G/B) / Sharpness / Gamma / Noise reduction / Progressive ] (pp.39-40)

Same function as computer menu.

## Zoom and Focus Adjustment

Rotate the Zoom Ring to zoom in and out.  
 Rotate the Focus Ring to adjust the focus of the image.

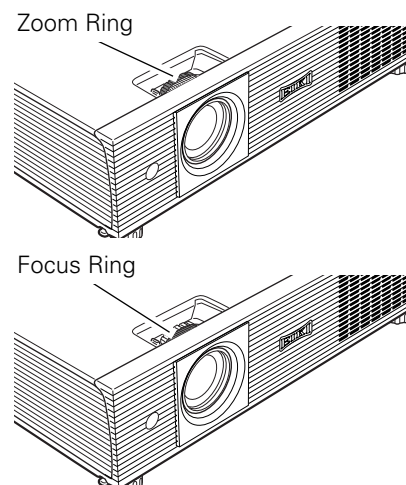

## Sound Adjustment

### Direct Operation

#### Volume

Press the VOLUME+/- buttons on the top control or on the remote control to adjust the volume. The volume dialog box will appear on the screen for a few seconds.

#### Mute

Press the MUTE button on the remote control to cut off the sound. To restore the sound to its previous level, press the MUTE button again or press the VOLUME+/- buttons. Mute function is also effective for AUDIO OUT jack.

### Menu Operation

- 1 Press the MENU button to display the On-Screen Menu. Press the Point ◀▶ buttons to move the red frame pointer to the Sound Menu icon.
- 2 Press the Point ▲▼ buttons to move the red framed pointer to the item that you want to select, and then press the SELECT button.

#### Volume

Press the Point ▶ button to turn up the volume, and press the Point ◀ button to turn down the volume.

#### Mute

Press the Point ◀▶ buttons to cut off the sound. Dialog box display will be changed to "On" and the sound will be cut off. To restore the sound to its previous level, press the Point ◀▶ buttons again.

### Top Control

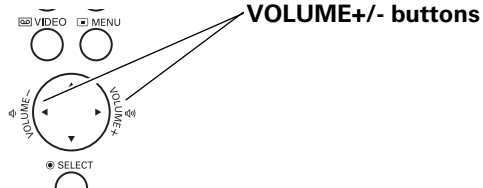

### Remote Control

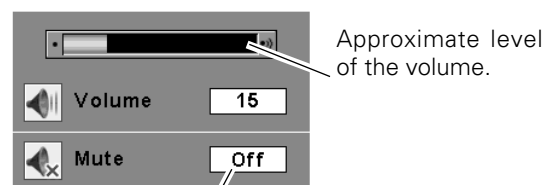
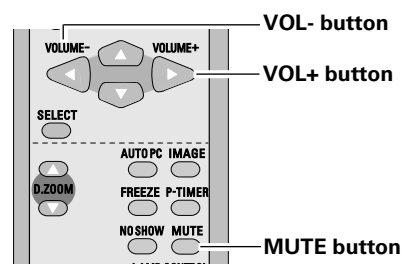

Press the MUTE button to set the Mute function On or Off. The display will disappear after 4 seconds.

### Sound Menu

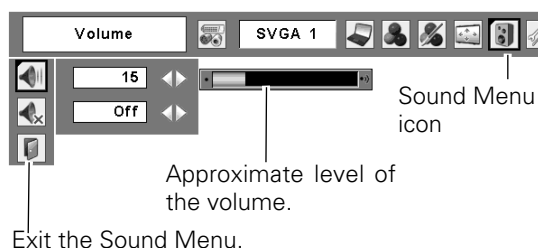

# Remote Control Operation

For some frequently used operations, using the remote control is advisable. Just pressing one of the buttons enables you to make the operation, and no need for calling up the On-Screen Menu.

### COMPUTER / VIDEO button

Press the COMPUTER or VIDEO button on the remote control to select the input source. For more detail, see pp.26, 35, 36.

### FREEZE button

Press the FREEZE button on the remote control to freeze the picture on the screen. To cancel the Freeze function, press the FREEZE button again or press any other button.

### KEYSTONE button

If a projected picture has keystone distortion, correct the image with Keystone adjustment.

Press the KEYSTONE button on the remote control. The keystone dialog box will appear.

Correct keystone distortion by pressing the Point ▲▼ buttons. Keystone adjustment can be memorized. (p.42)

Reduce the upper width with Point ▲ button.

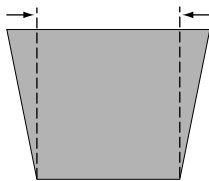

Reduce the lower width with Point ▼ button.

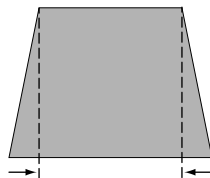

### Remote Control

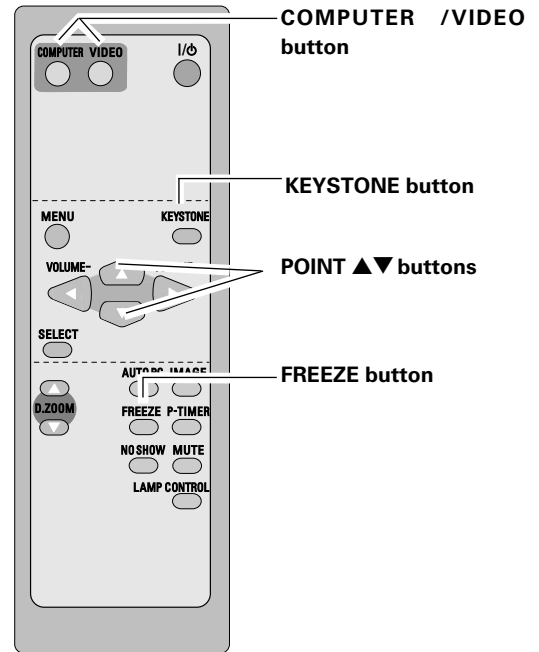

- The arrows are white when there is no correction.
- The direction of the arrow being corrected turns red.
- The arrows disappear at the maximum correction.
- If you press the KEYSTONE button on the remote control once more while the keystone dialog box is being displayed, the keystone adjustment will be canceled.
- The adjustable range can be limited depending on the input signal.

✓ **Note:**

- See the next page for the other buttons.



## AUTO PC button

Press the AUTO PC button on the remote control to operate the Auto PC function.

For more detail, see 28.

## D.ZOOM buttons

Press the D.ZOOM buttons on the remote control to zoom in and zoom out the images.

For more detail, see 34.

## NO SHOW button

Press the NO SHOW button on the remote control to black out the image. To restore to normal, press the NO SHOW button again or press any other button. When a projected image is captured and set as "User" in the Logo selection (p.43), the screen changes each time you press the NO SHOW button as follows.

black out → the captured image → normal → .....

## IMAGE button

Press the IMAGE button on the remote control to select a desired image level of the screen.

For more detail, see p31, 38.

## P-TIMER button

Press the P-TIMER button on the remote control. The timer display "00 : 00" will appear on the screen and the timer will start to count time (00 : 00 ~ 59 : 59).

To stop the P-Timer, press the P-TIMER button. Press the P-TIMER button again, then the P-timer display will disappear.

## LAMP CONTROL button

Press the LAMP CONTROL button on the remote control to select the lamp mode for changing the brightness of the screen.

- 💡 Auto .....brightness according with the input signal
- 💡 High .....brighter than the Normal mode
- 💡 Normal .....normal brightness
- 💡 Eco .....lower brightness reduces the lamp power consumption and extends the lamp life.

## Remote Control

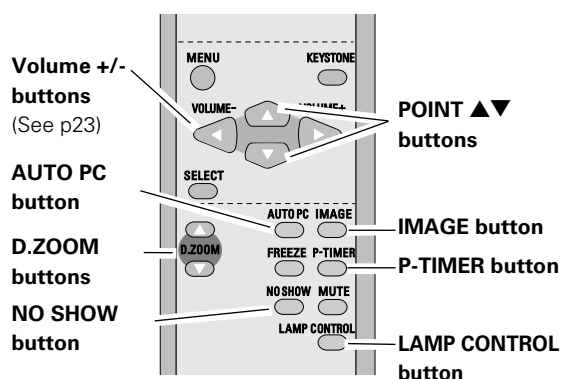

### ✓ Note:

- See the previous page for the other buttons.

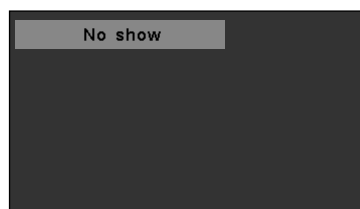

The message will disappear after 4 seconds.



P-Timer display

# Computer Input

## Input Source Selection

### Direct Operation

Choose either Computer 1 or Computer 2 by pressing the COMPUTER 1 button or COMPUTER 2 button on the top control or press the COMPUTER button on the remote control.

Before using these buttons, correct input source should be selected through Menu operation as described below.

### Top Control

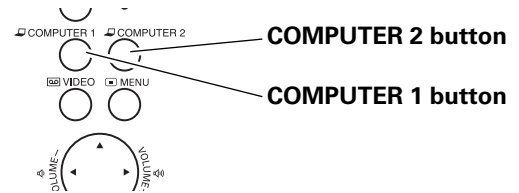

### REMOTE CONTROL

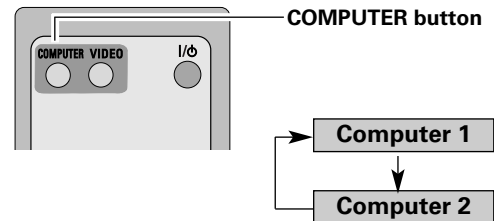

### Menu Operation

- 1 Press the MENU button to display the On-Screen Menu. Press the Point ◀▶ buttons to move the red frame pointer to the Input Menu icon.
- 2 Press the Point ▲▼ buttons to move the red arrow pointer to either Computer 1 or Computer 2, and then press the SELECT button.
- 3 When selecting Computer 1, input source will be selected directly. When selecting Computer 2, the Source Select Menu appears. Move the pointer to RGB and then press the SELECT button.

### Input Menu

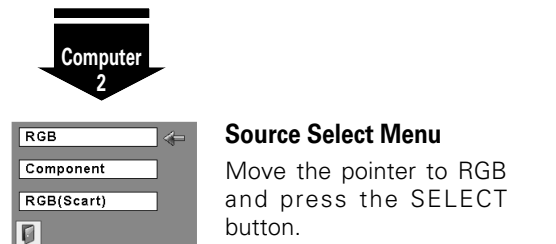
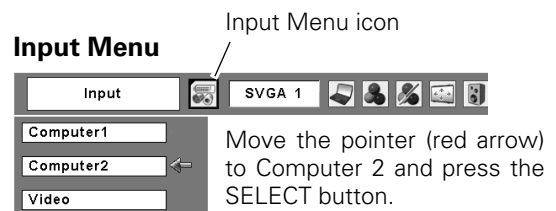
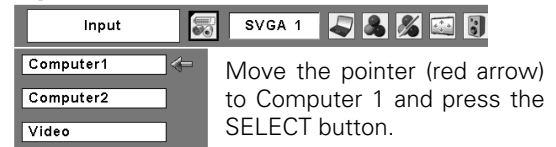

### ✓Notes:

- Computer 1 can accept only RGB signal.
- When the Input Search function is set to "On1" or "On2", the input signal will be searched automatically (p.45).

## Computer System Selection

This projector automatically tunes to various types of computers based on VGA, SVGA, XGA, SXGA, WXGA or UXGA with its Multi-scan system and Auto PC Adjustment. If Computer is selected as a signal source, this projector automatically detects the signal format and tunes to project a proper image without any additional setting. (Signal formats provided in this projector is shown on page 61 )

One of the following messages may appear when:

**Auto**

The projector cannot recognize the connected signal conforming to the provided PC Systems. The message "Auto" will be displayed on the PC System Menu icon and the Auto PC Adjustment function will work to display proper images. If the image is not projected properly, a manual adjustment is required. (pp.29, 30)

-----

There is no signal input from computer. Check the connection between your computer and the projector. (See "Troubleshooting" p.56)

**Mode 1**

The preset system is manually adjusted in the PC Adjust Menu. The adjusted data can be stored in Mode 1~5. (pp.29, 30)

**SVGA 1**

PC Systems provided in this projector is chosen. The projector chooses a proper system provided in the projector and displays it.

\*Mode 1 and SVGA 1 are examples.

### PC System Menu

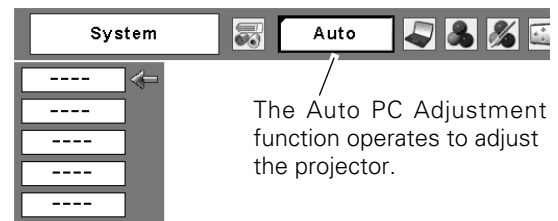

The Auto PC Adjustment function operates to adjust the projector.

### PC System Menu

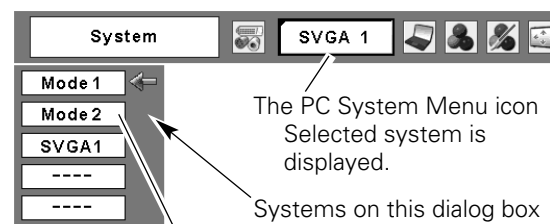

The PC System Menu icon Selected system is displayed.

Systems on this dialog box can be selected.

Customized Mode (1~5) set in the PC Adjust Menu. (pp.28, 30)

### Selecting Computer System Manually

PC system can also be selected manually.

- 1 Press the MENU button to display the On-Screen Menu. Press the Point ◀▶ buttons to move the red frame pointer to the PC System Menu icon.
- 2 Press the Point ▲▼ buttons to move the red arrow pointer to the system that you want to set, and then press the SELECT button.

## Auto PC Adjustment

Auto PC Adjustment function is provided to automatically adjust Fine sync, Total dots, Horizontal, and Vertical to conform to your computer. Auto PC Adjustment function can be operated as follows.

### Direct Operation

The Auto PC adjustment function can be operated directly by pressing the AUTO PC button on the remote control unit.

### Remote Control

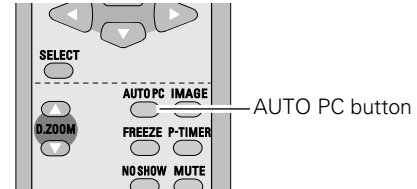

### Menu Operation

#### Auto PC Adj.

- 1 Press the MENU button to display the On-Screen Menu. Press the Point ◀▶ buttons to move the red frame pointer to PC Adjust Menu item.
- 2 Press the Point ▲▼ buttons to move the red frame pointer to Auto PC Adj. item and then press the SELECT button twice.

### To store adjustment parameters

Adjustment parameters from Auto PC Adjustment can be memorized in this projector. Once parameters are memorized, the setting can be done just by selecting Mode in the PC System Menu (p.27). See "Store" on page 30.

#### ✓ Notes:

- Fine sync, Total dots, Horizontal, and Vertical of some computers cannot be fully adjusted with this Auto PC Adjustment function. When the image is not provided properly with this operation, manual adjustments are required. (pp.29, 30)
- The Auto PC Adjustment cannot be operated when 480i, 575i, 480p, 575p, 720p, 1035i, or 1080i is selected in the PC System Menu(p.27)

### PC Adjust Menu

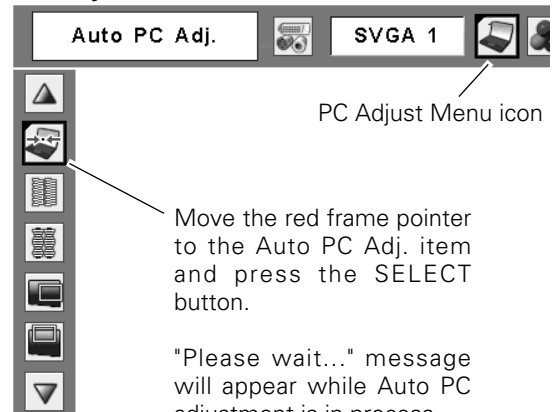

Move the red frame pointer to the Auto PC Adj. item and press the SELECT button.

"Please wait..." message will appear while Auto PC adjustment is in process.

## Manual PC Adjustment

Some computers employ special signal formats which may not be tuned by Multi-scan system of this projector. Manual PC Adjustment enables you to precisely adjust several parameters to match those signal formats. The projector has 5 independent memory areas to memorize those parameters manually adjusted. It allows you to recall the setting for a specific computer.

**1** Press the MENU button to display the On-Screen Menu. Press the Point ◀▶ buttons to move the red frame pointer to the PC Adjust Menu icon.

**2** Press the Point ▲▼ buttons to move the red frame pointer to the item that you want to adjust and then press the SELECT button to display the adjustment dialog box. Press the Point ◀▶ buttons to adjust the value.

### Fine sync

Use the Point ◀▶ buttons to adjust the value, eliminating a flicker from the image displayed (from 0 to 31).

### Total dots

Use the Point ◀▶ buttons to adjust the number of total dots in one horizontal period to match your PC image.

### Horizontal

Use the Point ◀▶ buttons to adjust the horizontal picture position.

### Vertical

Use the Point ◀▶ buttons to adjust the vertical picture position.

### Current mode

Press the SELECT button to show H-sync freq. and V-sync freq. of the connected computer.

### Clamp

Use the Point ◀▶ buttons to adjust the clamp level. When the image has dark bars, try this adjustment.

**PC Adjust Menu** PC Adjust Menu icon

Auto PC Adj. SVG A 1

Move the red framed pointer to an item and press the SELECT button.

Status (Stored / Free) of the selected Mode.

Selected Mode

Auto PC Adj. Mode1 Stored

Press the Point ◀▶ buttons to adjust the value.

15 ◀▶  
1346 ◀▶  
301 ◀▶  
39 ◀▶

Press the SELECT button at this item to adjust other items.

Current mode Mode1 Stored

H-sync freq. 48.5  
V-sync freq. 60.0

1 ◀▶  
640 ◀▶  
480 ◀▶

Press the SELECT button at the Current mode item to show the information of the connected computer.

## Display area H

Use the Point ◀▶ buttons to adjust the horizontal area displayed by this projector.

## Display area V

Use the Point ◀▶ buttons to adjust the vertical area displayed by this projector.

## Reset

To reset the adjusted data, select Reset and press the SELECT button. The confirmation box will appear and then select [Yes]. All adjustments will return to their previous figures.

## Mode free

To clear the stored data, select Mode free and then press the SELECT button. Move the red arrow pointer to the Mode that you want to clear and then press the SELECT button.

## Store

To store the adjusted data, select Store and then press the SELECT button. Move the red arrow pointer to one of the Modes 1 to 5 in which you want to store, and then press the SELECT button.

## Quit

Exit the PC Adjust Menu.

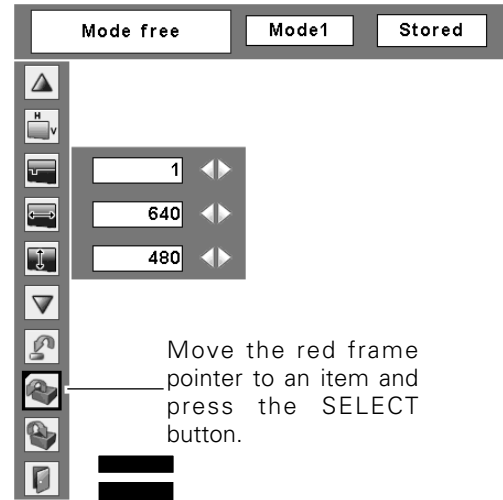

Move the red frame pointer to an item and press the SELECT button.

## To clear adjusted data

This Mode has stored parameters.

Where to free?

Mode1	Stored	800	142	34	1024	768
Mode2	Free	800	142	34	1024	768
Mode3	Free	800	142	34	1024	768
Mode4	Free	800	142	34	1024	768
Mode5	Free	800	142	34	1024	768

Vacant

Values of "Total dots," "Horizontal," "Vertical," "Display area H," and "Display area V."

## To store adjusted data

Where to store?

Mode1	Stored	800	142	34	1024	768
Mode2	Free	800	142	34	1024	768
Mode3	Free	800	142	34	1024	768
Mode4	Free	800	142	34	1024	768
Mode5	Free	800	142	34	1024	768

Close this dialog box.

### ✓Note:

Display area (H/V) cannot be selected when 480i, 575i, 480p, 575p, 720p, 1035i, or 1080i is selected in the PC System Menu (p.27).

## Image Mode Selection

### Direct Operation

Select the desired image mode from among Dynamic, Standard, Real, Blackboard (Green), Image 1, Image 2, Image 3, and Image 4 by pressing the IMAGE button on the remote control.

#### Dynamic

For viewing pictures in a bright room.

#### Standard

Normal picture mode preset on the projector.

#### Real

Picture mode with improved halftone for graphics.

#### Blackboard (Green)

For the image projected on a blackboard.  
This mode help enhance the image projected on a blackboard.  
This is mainly effective on a green colored board, not truly effective on a black colored board.

#### Image 1-4

For viewing with the user preset image mode in the Image Adjust Menu (see page 33). This Image memory is provided in each computer, component, and video input source.

### Menu Operation

- 1 Press the MENU button to display the On-Screen Menu. Use the Point ◀▶ buttons to move the red frame pointer to the Image Select Menu icon.
- 2 Use the Point ▲▼ buttons to move the red frame pointer to the desired image mode and then press the SELECT button.

#### Dynamic

For viewing pictures in a bright room.

#### Standard

Normal picture mode preset on the projector.

#### Real

Picture mode with improved halftone for graphics.

#### Blackboard(Green)

For the image projected on a blackboard. See above for further description.

#### Image 1-4

For viewing with the user preset image mode in the Image Adjust Menu (see page 33).

### Remote Control

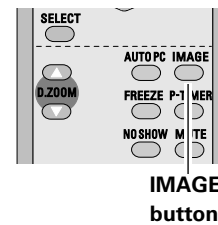

### IMAGE button

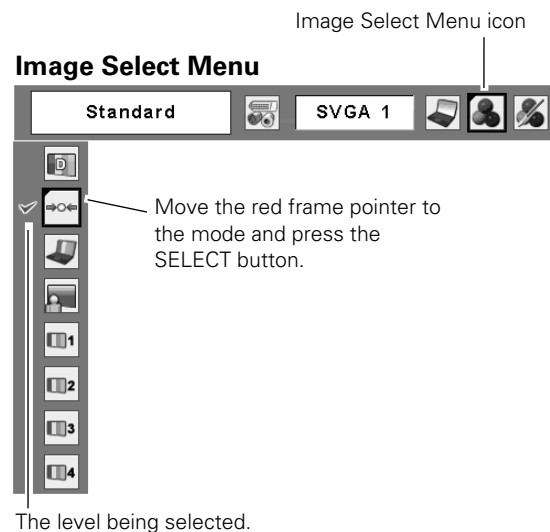
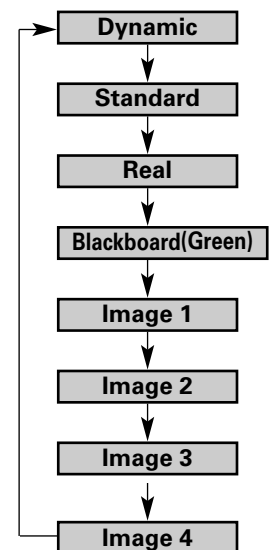

## Image Adjustment

- 1 Press the MENU button to display the On-Screen Menu. Press the Point ◀▶ buttons to move the red frame pointer to the Image Adjust Menu icon.
- 2 Use the Point ▲▼ buttons to move the red frame pointer to the desired item and then press the SELECT button to display the adjustment dialog box. Use the Point ◀▶ buttons to adjust the setting value.

### Contrast

Press the Point ◀ button to decrease the contrast; press the Point ▶ button to increase the contrast (from 0 to 63).

### Brightness

Press the Point ◀ button to decrease the brightness; press the Point ▶ button to increase the brightness (from 0 to 63).

### Color temp.

Use the Point ◀▶ buttons to select the desired Color temp. level (High, Mid, Low, or XLow).

### White balance (Red)

Press the Point ◀ button to lighten red tone; press the Point ▶ button to deepen red tone (from 0 to 63).

### White balance (Green)

Press the Point ◀ button to lighten green tone; press the Point ▶ button to deepen green tone (from 0 to 63).

### White balance (Blue)

Press the Point ◀ button to lighten blue tone; press the Point ▶ button to deepen blue tone (from 0 to 63).

### Sharpness

Press the Point ◀ button to decrease the sharpness of the image; press the Point ▶ button to increase the sharpness of the image (from 0 to 15).

### Gamma

Use the Point ◀▶ buttons to adjust the gamma value to obtain a better balance of contrast (from 0 to 15).

### Reset

To reset the adjusted data, select Reset and press the SELECT button. A confirmation box appears and then select [Yes]. All adjustments will return to their previous figures.

### Image Adjust Menu

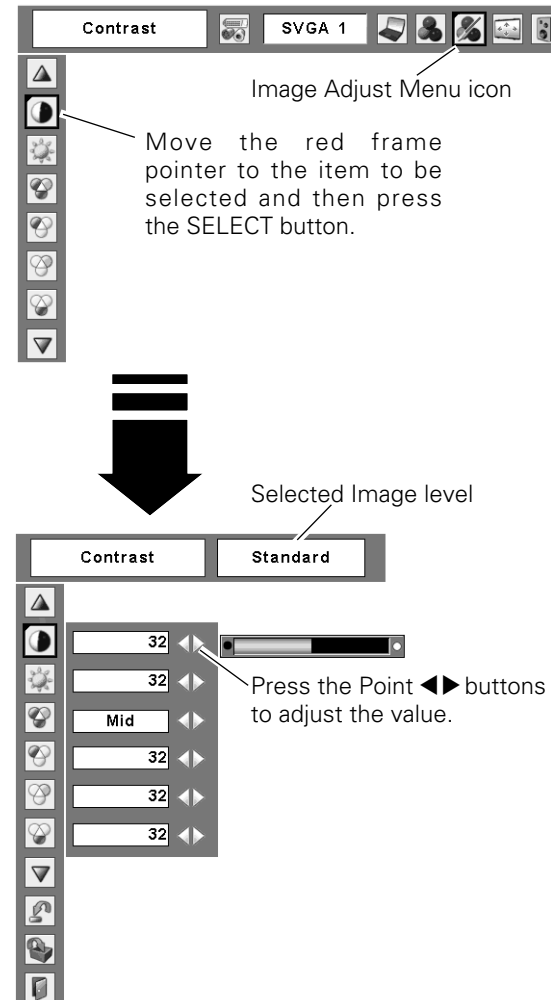

#### ✓ Note:

After adjusting any of the White balance Red, Green or Blue, the Color temp will change to "Adj."



 **Store**

To store the adjusted data, select Store and press the SELECT button. Use the Point ▲▼ buttons to select one from Image 1 to 4 and press the SELECT button. A confirmation box appears and then select [Yes]. Stored data can be called up by selecting "Image (1-4)" in the Image Select Menu on page 31.

 **Quit**

Exit the Image Adjust Menu.

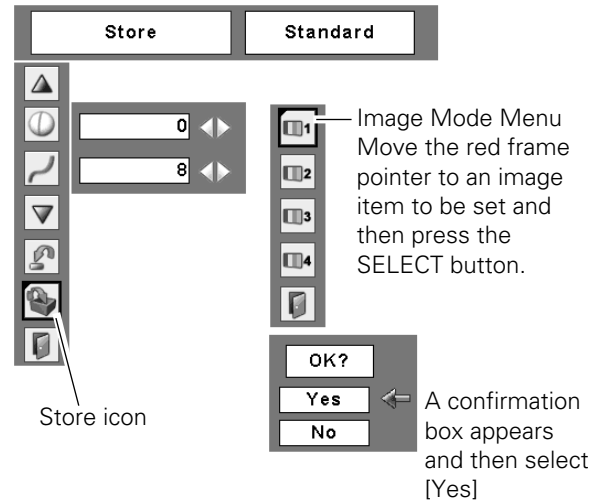

## Screen Size Adjustment

This projector has the picture screen resize function, which enables you to customize the image size.

- 1 Press the MENU button to display the On-Screen Menu. Press the Point ◀▶ buttons to move the red frame pointer to the Screen Menu icon.
- 2 Use the Point ▲▼ buttons to move the red frame pointer to the desired function and then press the SELECT button.

 **Normal**

Provide the image to fit the screen size.

 **True**

Provide the image in its original size. When the original image size is larger than the screen size (1024 x 768), the projector enters panning mode automatically. Pan the image with Point ▲▼◀▶ buttons. When adjusted, the arrows will turn red. When reached to the correction limit, the arrows will disappear.

 **Wide**

Provide the image to fit wide video aspect ratio (16 : 9) by expanding the image width uniformly. This function can be used for providing a squeezed video signal at 16 : 9.

 **Full screen**

Provide the full screen image.

**Screen Menu**

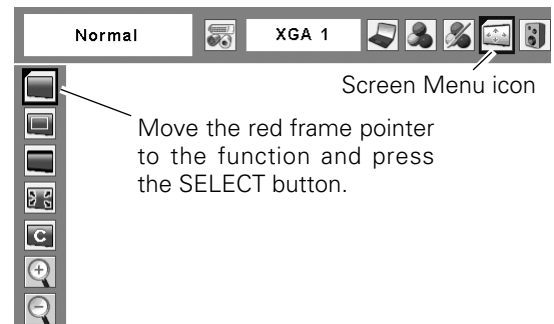

✓ **Notes:**

- The Screen Menu, except for "Normal" and "Custom", cannot be operated when 720p, 1035i, or 1080i is selected in the PC System Menu (p.27).
- The projector cannot display any resolution higher than 1600 X 1200. If your computer's screen resolution is higher than it, reset the resolution to the lower before connecting to the projector.
- The image data other than 1024 x 768 is modified to fit the screen size in initial mode.
- True, Full screen, and Digital zoom +/- cannot be selected when 480i, 575i, 480p, or 575p is selected in the PC System Menu (p.27).

## Custom

Adjust the screen scale and position manually with this function.

Press the SELECT button at Custom and the "Custom" is displayed on the screen for a few seconds and then the Aspect dialog box appears.

- Scale H/V..... Adjust the Horizontal/Vertical screen scale.
- H&V..... When set to "On," the aspect ratio is fixed. The "Scale V" appears dimmed and becomes unavailable. Adjust "Scale H," then the screen scale is automatically modified based on the aspect ratio.
- Position H/V ..... Adjust the Horizontal/Vertical screen position.
- Common ..... Save the adjusted scale to all the inputs. Press the SELECT button at Common to display a confirmation box. To save the scale, press the SELECT button at "Yes." When Custom is selected, the saved scale is used.
- Reset..... Reset the all adjusted values. Press the SELECT button at Reset to display a confirmation box. To reset, press the SELECT button at "Yes."

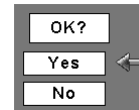
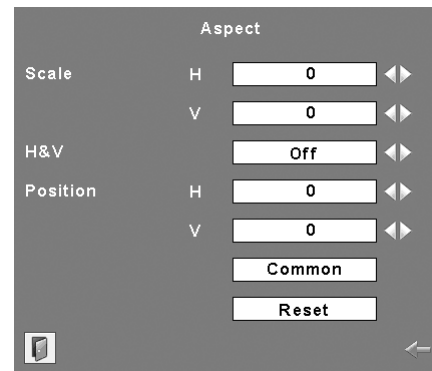

Press the SELECT button at Common or Reset, to display a confirmation box.

### ✓ Notes:

- When no signal is detected, "Normal" is set automatically and the Aspect dialog box disappears.
- The adjustable range for Scale H/V and Position H/V is limited depending on the input signal.

## For zooming in and out the images

### Digital zoom +

Select Digital zoom +. The On-Screen Menu disappears and "D. zoom +" appears. Press the SELECT button to expand the image size. Use the Point  buttons to pan the image. The Panning function can work only when the image is larger than the screen size.

A projected image can be also expanded by pressing the D.ZOOM  button on the remote control.

### Digital zoom -

Select Digital zoom -. The On-Screen Menu disappears and "D. zoom -" appears. Press the SELECT button to compress image size.

The projected image can be also compressed by pressing the D.ZOOM  button on the remote control.

To exit the Digital zoom +/- mode, press any button except the D.ZOOM  buttons, SELECT, and Point buttons.

To return to the previous screen size, select a screen size from the Screen Size Adjustment Menu or select an input source from the Input Source Selection Menu (see page 26) again, or adjust the screen size with the D.ZOOM  buttons.

## Remote Control

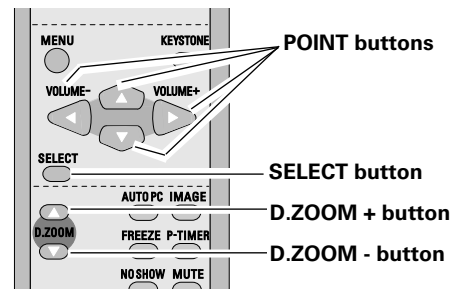

### ✓ Notes:

- The panning function may not operate properly if the stored Mode in the PC Adjust Menu is used. (p.30)
- The minimum compression ratio can be limited depending on the input signal or when the Keystone function is working.
- True, Full screen, and Digital zoom +/- cannot be selected when 480i, 575i, 480p, or 575p is selected in the PC System Menu (p.27).
- Digital zoom +/- cannot be selected when Full screen or True is selected.

# Video Input

## Input Source Selection (Video, S-Video)

### Direct Operation

Choose Video by pressing the VIDEO button on the top control or the remote control.  
Before using these buttons, correct input source should be selected through menu operation as described below.

### Top Control

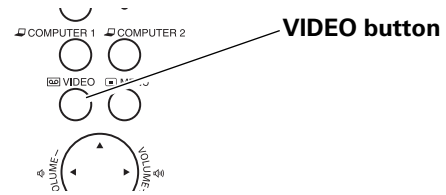

### REMOTE CONTROL

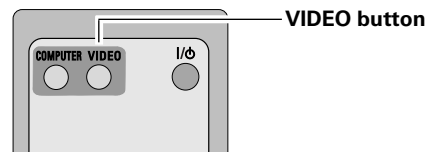

### Menu Operation

- 1 Press the MENU button to display the On-Screen Menu. Press the Point ◀▶ buttons to move the red frame pointer to the Input Menu icon.
- 2 Press the Point ▲▼ buttons to move the red arrow pointer to Video and then press the SELECT button to display the Source Select Menu .
- 3 Move the pointer to the desired source and then press the SELECT button.

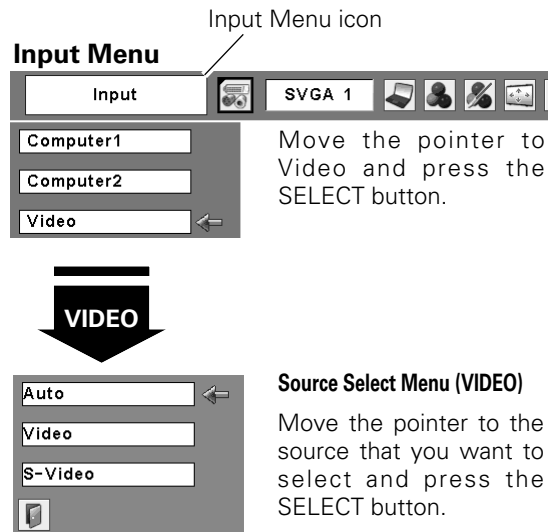

#### Auto

When selecting Auto, the projector automatically detects incoming video signal, and adjusts itself to optimize its performance. The projector selects connection in the following order:

1. S-Video
2. Video

#### Video

When video input signal is connected to the VIDEO jack, select Video.

#### S-Video

When video input signal is connected to the S-VIDEO jack, select S-Video.

#### ✓Note:

- When the Input Search function is set to "On1" or "On2", the input signal will be searched automatically (p.45).

## Input Source Selection (Component, RGB Scart 21-pin)

### Direct Operation

Choose Computer 2 by pressing the COMPUTER 2 button on the top control or press the COMPUTER button on the remote control.

Before using these buttons, correct input source should be selected through Menu operation as described below.

### Top Control

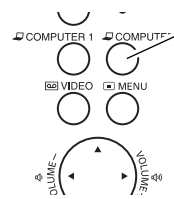

COMPUTER 2 button

### REMOTE CONTROL

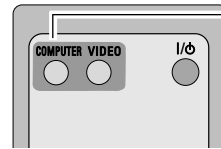

COMPUTER button

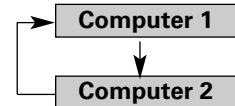

### Menu Operation

- 1 Press the MENU button to display the On-Screen Menu. Press the Point ◀▶ buttons to move the red frame pointer to the Input Menu icon.
- 2 Press the Point ▲▼ buttons to move the red arrow pointer to Computer 2 and then press the SELECT button.
- 3 After the Source Select Menu appeared for Computer 2, move the pointer to Component or RGB(Scart) and then press the SELECT button.

### Input Menu

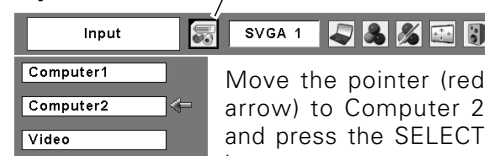

Input Menu icon

Move the pointer (red arrow) to Computer 2 and press the SELECT button.



### Source Select Menu

Move the pointer to Component or RGB(Scart) and press the SELECT button.

**Component** When the input source is coming from video equipment connected to the COMPUTER IN 2 / COMPONENT IN terminal with a Component-VGA Cable, select Component.

**RGB (Scart)** When the input source is coming from video equipment connected to the COMPUTER IN 2 / COMPONENT IN terminal with a Scart-VGA Cable, select RGB (Scart).

✓ **Note:**

- When the Input Search function is set to "On1" or "On2", the input signal will be searched automatically (p.45).

## Video System Selection

- 1 Press the MENU button to display the On-Screen Menu. Press the Point ◀▶ buttons to move the red frame pointer to the AV System Menu icon.
- 2 Use the Point ▲▼ buttons to move the red arrow pointer to the desired system and then press the SELECT button.

### Video or S-Video

#### Auto

The projector automatically detects an incoming video system, and adjusts itself to optimize its performance. When Video System is PAL-M or PAL-N, select system manually.

#### PAL / SECAM / NTSC / NTSC4.43 / PAL-M / PAL-N

If the projector cannot reproduce proper video image, select a specific broadcast signal format from among PAL, SECAM, NTSC, NTSC 4.43, PAL-M, and PAL-N.

#### AV System Menu (Video or S-Video)

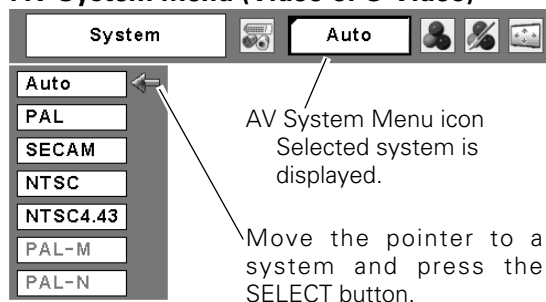

### Component

#### Auto

The projector automatically detects an incoming video signal, and adjusts itself to optimize its performance.

#### COMPONENT VIDEO SIGNAL FORMAT

If the projector cannot reproduce proper video image, select a specific component video signal format from among 480i, 575i, 480p, 575p, 720p, 1035i, and 1080i.

#### AV System Menu (Component)

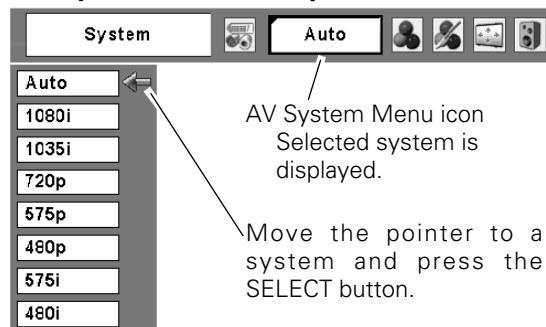

✓ **Note:**

The AV System Menu cannot be selected when selecting RGB(Scart).

## Image Mode Selection

### Direct Operation

Select the desired image mode from among Dynamic, Standard, Cinema, Blackboard (Green), Image 1, Image 2, Image 3, and Image 4 by pressing the IMAGE button on the remote control.

#### Dynamic

For viewing pictures in a bright room.

#### Standard

Normal picture mode preset on the projector.

#### Cinema

Picture mode adjusted with fine tone.

#### Blackboard (Green)

For the image projected on a blackboard.  
This mode help enhance the image projected on a blackboard.  
This is mainly effective on a green colored board, not truly effective on a black colored board.

#### Image 1-4

For viewing with the user preset image mode in the Image Adjust Menu (see page 39-40). This Image memory is provided in each computer, component, and video input source.

### Menu Operation

- 1 Press the MENU button to display the On-Screen Menu. Use the Point ◀▶ buttons to move the red frame pointer to the Image Select Menu icon.
- 2 Use the Point ▲▼ buttons to move the red frame pointer to the desired image mode and then press the SELECT button.

#### Dynamic

For viewing pictures in a bright room.

#### Standard

Normal picture mode preset on the projector.

#### Cinema

Picture mode adjusted with fine tone.

#### Blackboard(Green)

For the image projected on a blackboard. See above for further description.

#### Image1-4

For viewing with the user preset image mode in the Image Adjust Menu (see page 39-40).

### Remote Control

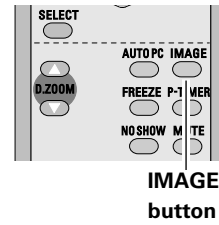

### IMAGE button

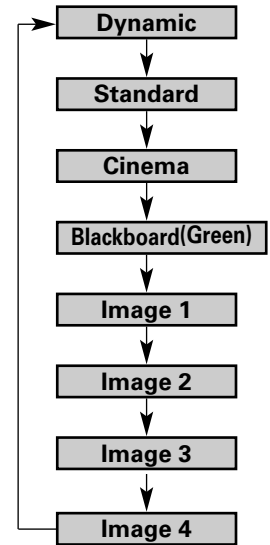

### Image Select Menu

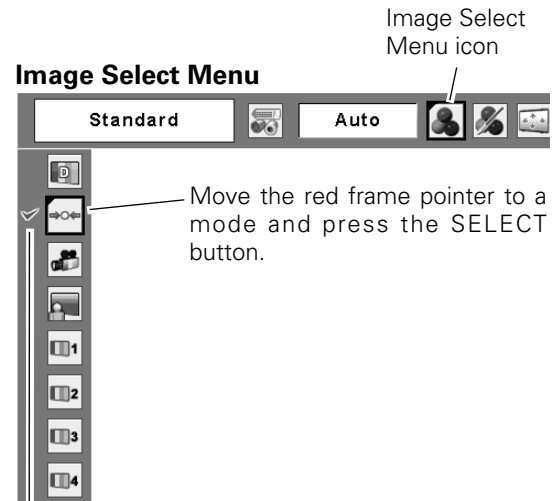

The selected image mode is check marked.

## Image Adjustment

- 1 Press the MENU button to display the On-Screen Menu. Press the Point ◀▶ buttons to move the red frame pointer to the Image Adjust Menu icon.
- 2 Use the Point ▲▼ buttons to move the red frame pointer to the desired item and then press the SELECT button to display the adjustment dialog box. Use the Point ◀▶ buttons to adjust the setting value.

### Contrast

Press the Point ◀ button to decrease the contrast; press the Point ▶ button to increase the contrast (from 0 to 63).

### Brightness

Press the Point ◀ button to decrease the brightness; press the Point ▶ button to increase the brightness (from 0 to 63).

### Color

Press the Point ◀ button decrease the intensity of the color; press the Point ▶ button increase the intensity of the color (from 0 to 63).

### Tint

Press the Point ◀▶ buttons to adjust the tint value to get a proper color balance (from 0 to 63).

### Color temp.

Use the Point ◀▶ buttons to select the desired Color temp. level (High, Mid, Low, or XLow).

### White balance (Red)

Press the Point ◀ button to lighten red tone; press the Point ▶ button to deepen red tone (from 0 to 63).

### White balance (Green)

Press the Point ◀ button to lighten green tone; press the Point ▶ button to deepen green tone (from 0 to 63).

### White balance (Blue)

Press the Point ◀ button to lighten blue tone; press the Point ▶ button to deepen blue tone (from 0 to 63).

#### ✓ Notes:

- The Tint cannot be selected when the video system is PAL, SECAM, PAL-M, or PAL-N.
- When the White balance Red, Green, or Blue is adjusted, the Color temp. level will change to "Adj."

### Image Adjust Menu

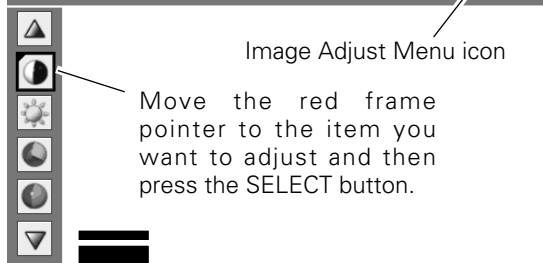
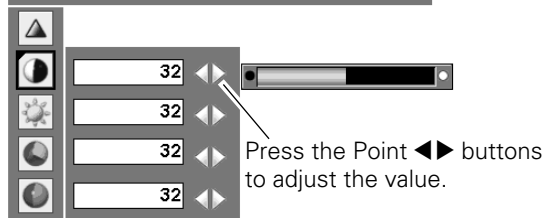
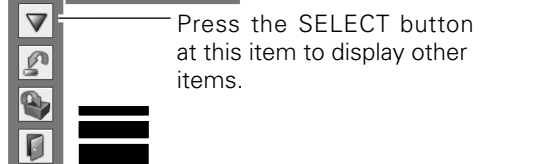

Image Adjust Menu icon  
Move the red frame pointer to the item you want to adjust and then press the SELECT button.



Press the Point ◀▶ buttons to adjust the value.



Press the SELECT button at this item to display other items.

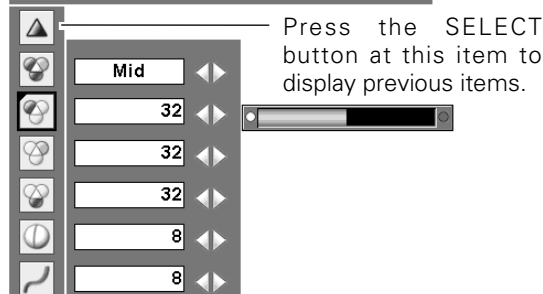

Press the SELECT button at this item to display previous items.

## Sharpness

Press the Point ◀ button to decrease the sharpness of the image; press the Point ▶ button to increase the sharpness of the image (from 0 to 15).

## Gamma

Use the Point ◀▶ buttons to adjust the gamma value to obtain a better balance of contrast (from 0 to 15).

## Noise reduction

Noise interference on the screen can be reduced. Select one of the following options to get smoother images.

Off..... Disabled.

L1 ..... Lower reduction

L2 ..... Higher reduction

## Progressive

An interlaced video signal can be displayed in progressive mode. Select one of the following options.

Off..... Disabled.

L1 ..... For an active picture.

L2 ..... For a still picture.

Film ..... For watching a film. With this function, the projector reproduces pictures faithful to the original film quality.

## Reset

To reset the adjusted data, select Reset and press the SELECT button. A confirmation box appears and then select [Yes]. All adjustments will return to their previous figures.

## Store

To store the adjusted data, select Store and press the SELECT button. Use the point ▲▼ buttons to select one from Image 1 to 4 and press the SELECT button.

A confirmation box appears and then select [Yes]. Stored data can be called up by selecting "Image (1-4)" in the Image Select Menu on page 38.

## Quit

Exit the Image Adjust Menu.

### ✓ Notes:

- Noise reduction and Progressive cannot be selected when 480p, 575p, 720p, 1035i, or 1080i is selected. (p.37)
- Reset and Store icons will be displayed when any adjustment is made.

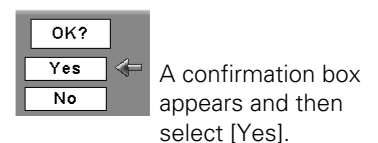
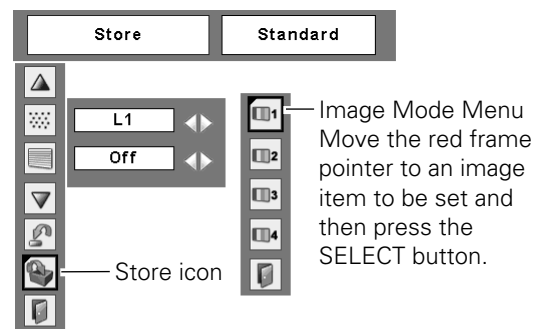



## Screen Size Adjustment

This projector has the picture screen resize function, which enables you to customize the image size.

- 1 Press the MENU button to display the On-Screen Menu. Use the Point ◀▶ buttons to move the red frame pointer to the Screen Menu icon.
- 2 Use the Point ▲▼ buttons to move the red frame pointer to the desired function and then press the SELECT button.

### Screen Menu



Screen Menu icon

Move the red frame pointer to the desired function and press the SELECT button.

#### Normal

Provide the image at the 4:3 normal video aspect ratio.

#### Wide

Provide the image at the 16:9 wide screen ratio.

#### Custom

Adjust the screen scale and position manually with this function.

Press the SELECT button at Custom and the "Custom" is displayed on the screen for a few seconds and then the Aspect dialog box appears.

- Scale H/V..... Adjust the Horizontal/Vertical screen scale.
- H&V..... When set to "On," the aspect ratio is fixed. The "Scale V" appears dimmed and becomes unavailable. Adjust the "Scale H," then the screen scale is automatically modified based on the aspect ratio.
- Position H/V ..... Adjust the Horizontal/Vertical screen position.
- Common ..... Save the adjusted scale to all the inputs. Press the SELECT button at Common to display a confirmation box. To save the scale, press the SELECT button at "Yes." When Custom is selected, the saved scale is used.
- Reset..... Reset the all adjusted values. Press the SELECT button at Reset to display a confirmation box. To reset, press the SELECT button at "Yes."

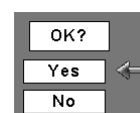
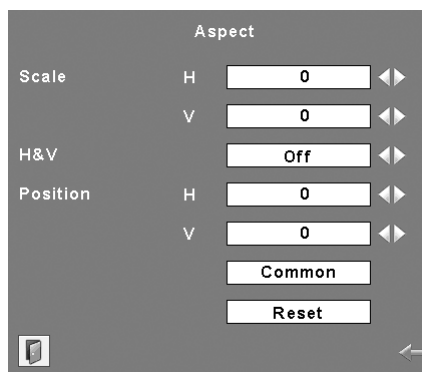

Press the SELECT button at Common or Reset, to display a confirmation box.

#### ✓Notes:

- When no signal is detected, "Normal" is set automatically and the Aspect dialog box disappears.
- The adjustable range for Scale H/V and Position H/V is limited depending on the input signal.
- "Wide" cannot be operated when 720p, 1035i, or 1080i is selected in the AV System Menu (p.37).

## Setting

This projector has Setting menu that allows you to set up the other various functions described as follows;

- 1 Press the MENU button to display the On-Screen Menu. Press the Point ◀▶ buttons to move the red frame pointer to the Setting Menu icon.
- 2 Press the Point ▲▼ buttons to move the red frame pointer to the item that you want to set and then press the SELECT button. The Setting dialog box appears.

### Language

The language used in the On-Screen Menu is available in English, German, French, Italian, Spanish, Portuguese, Dutch, Swedish, Finnish, Polish, Hungarian, Romanian, Russian, Chinese, Korean, or Japanese.

### Keystone

This function corrects distortion of a projected image. Select either Store or Reset with the Point ◀▶ buttons, and then press the SELECT button. The keystone dialog box will appear. Correct keystone with the Point ▲▼ buttons. (p.24)

Store .....store the keystone correction even when the AC power cord is unplugged.

Reset .....reset the keystone correction when the AC power cord is unplugged.

### Blue back

Press the Point ◀▶ buttons to switch On/Off. When this function is "On," a blue image is displayed while the input signal is not detected.

### Display

Press the Point ◀▶ buttons to switch On/Off. This function decides to display On-Screen Displays.

On .....Show all the On-Screen Displays. Use this function when you want to project images after the lamp becomes bright enough. Factory default setting is this mode.

Countdown off .....Show the input image instead of the countdown when turning on the projector. Use this function when you want to project the image as early as possible even when the lamp is not bright enough.

Off .....Do not show On-Screen Displays. except;

- On-Screen Menu
- "Power off?" message
- P-Timer
- "No signal" message for Power management item (p46)
- "Please wait..." message
- White arrows for True item in the Screen Menu (p33)

### Setting Menu (Language)

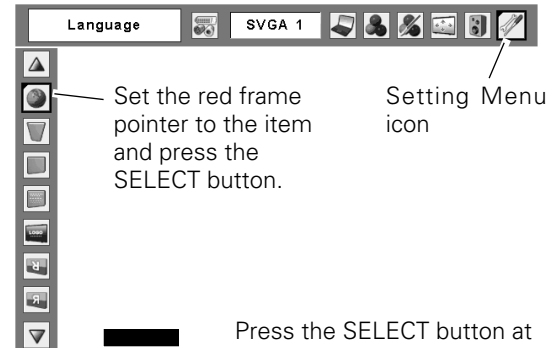

Press the SELECT button at Language item, the Language Menu will appear.

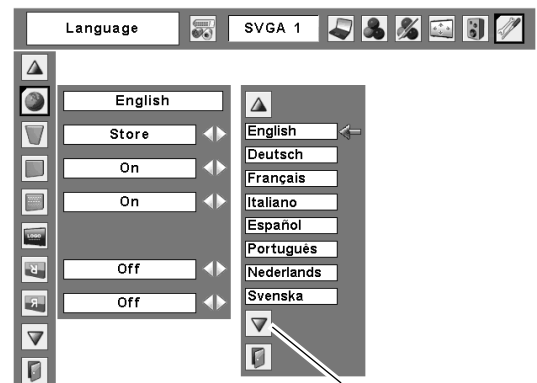

Press the SELECT button at this item to display the other languages.

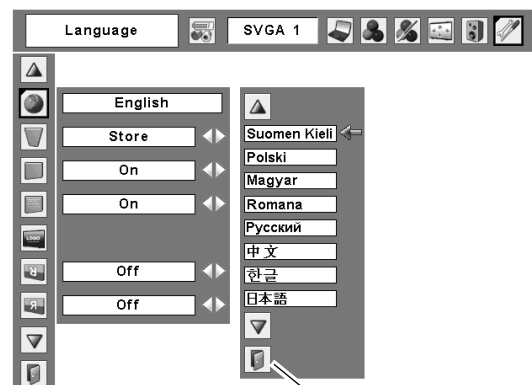

Press the SELECT button at this item to close the dialog box.

 **Logo (Logo and Logo PIN code lock settings)**

This function allows you to customize the screen logo with Logo select, Capture, and Logo PIN code lock functions.

**✓ Note:**

When On is selected in Logo PIN code lock function, Logo select and Capture functions cannot be selected.

 **Logo select**

This function decides the start-up display as follows:

- User .....the image you captured
- Default .....the factory-set logo
- Off.....countdown only

 **Capture**

This function enables you to capture the image being projected and use it for a start-up display or interval of presentations.

After capturing the projected image, go to the Logo select function and set it to "User". Then the captured image will be displayed when turning on the projector next time or pressing the NO SHOW button. (p.25)

To capture the image, select [Yes]. To cancel the Capture function, select [No].

**✓ Notes:**

- Before capturing an image, select Standard in the Image Select Menu to capture a proper image. (pp.31, 38.)
- A signal from a computer can be captured up to XGA(1024 x 768). A signal from video equipment can be captured except for 720p, 1035i, and 1080i.
- When capturing the image that has been adjusted by the Keystone function, the adjustment data is automatically reset and the projector captures an image without keystone adjustment.
- When the Logo PIN code lock function is On, Capture menu cannot be selected.
- When starting to capture a new image, the previously stored image is cleared even if you cancel the capturing.

**Logo select**

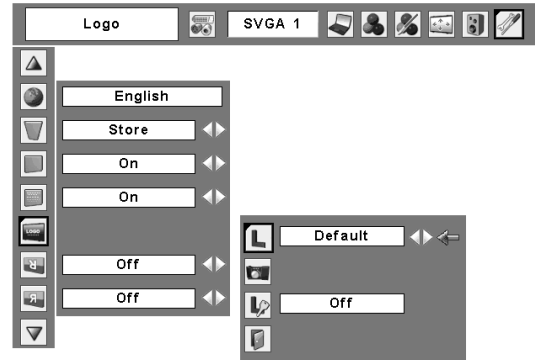

**Capture**

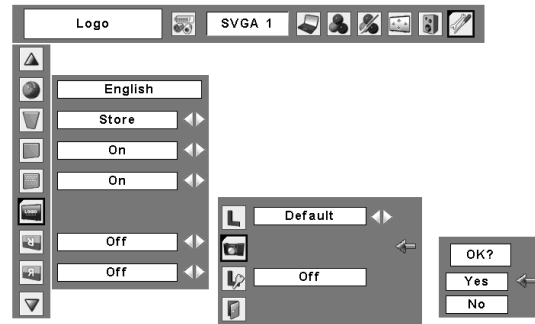

Select [Yes] to capture the projected image.

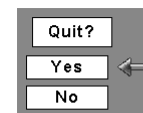

Select [Yes] to stop capturing.



**Logo PIN code lock**

This function prevents an unauthorized person from changing the screen logo.

- Off..... The screen logo can be changed freely from the Logo Menu (p.43).
- On..... The screen logo cannot be changed without a Logo PIN code.

If you want to change the Logo PIN code lock setting, press the SELECT button and the Logo PIN code dialog box appears. Enter a Logo PIN code by following the steps below. The initial Logo PIN code is set to "4321" at the factory.

**Enter a Logo PIN code**

Use the Point ▲▼ buttons to enter a number. Press the Point ► button to fix the number and move the red frame pointer to the next box. The number changes to "\*." If you fixed an incorrect number, use the Point ◀ button to move the pointer to the number you want to correct, and then enter the correct number.

Repeat this step to complete entering a four-digit number.

After entering the four-digit number, move the pointer to "Set." Press the SELECT button so that you can start to operate the projector.

If you entered an incorrect Logo PIN code, "Logo PIN code" and the number (\*\*\*\*) will turn red for a moment. Enter the correct Logo PIN code all over again.

**Change the Logo PIN code lock setting**

Use the Point ◀► button to switch On/Off, and then press the Point ▼ button to move the pointer to "Quit." Press the SELECT button to close the dialog box.

**Change the Logo PIN code**

Logo PIN code can be changed to your desired four-digit number. Press the Point ▼ button to select "Logo PIN code change" and then press the SELECT button. The New Logo PIN code input dialog box appears. Set a new Logo PIN code.

Be sure to note the new Logo PIN code and keep it at hand. If you lost the number, you could no longer change the Logo PIN code setting. For details on PIN code setting, refer to "PIN code lock" on page 48.

**Logo PIN code lock**

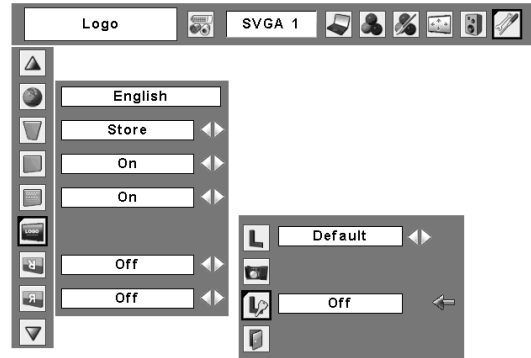

**Enter a Logo PIN code**

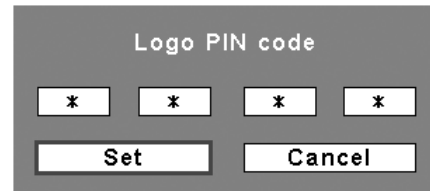

After a correct Logo PIN code is entered, the following dialog box appears.

**Change the Logo PIN code lock setting**



Use the Point ◀► buttons to switch On/Off.

**Change the Logo PIN code**

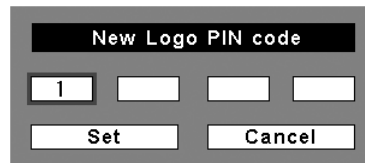

**CAUTION:**  
**WHEN YOU HAVE CHANGED THE LOGO PIN CODE, WRITE DOWN THE NEW PIN CODE IN COLUMN OF THE LOGO PIN CODE NO. MEMO ON PAGE 65, AND KEEP IT SECURELY. SHOULD THE LOGO PIN CODE BE LOST OR FORGOTTEN, THE LOGO PIN CODE SETTING CAN NO LONGER BE CHANGED.**

 **Ceiling**

When this function is set to "On," the picture will be top/bottom and left/right reversed. This function is used to project the image from a ceiling-mounted projector.

**Ceiling**

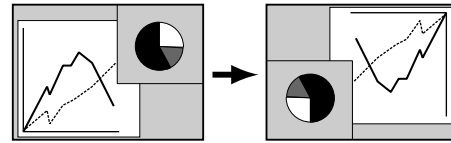

 **Rear**

When this function is set to "On," the picture will be left/right reversed. This function is used to project the image from rear of the screen.

**Rear**

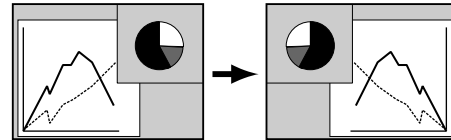

 **Input search**

This function detects the input signal automatically. When a signal is found, the search will stop. Use the Point ◀▶ buttons to select one of the following options.

- Off..... Input search will not work.
- On1 ..... Input search works under the following situation.
  - When pressing the COMPUTER 1 button, COMPUTER 2 button or VIDEO button on the top control.
  - When pressing the COMPUTER button or VIDEO button on the remote control.
- On2 ..... Input search works under the following situation.
  - When turning on the projector by pressing the ON/STAND-BY button on the top control or the remote control.
  - When pressing the COMPUTER 1 button, COMPUTER 2 button or VIDEO button on the top control.
  - When pressing the COMPUTER button or VIDEO button on the remote control.
  - When the current input signal is cut off.\*

\*If the No show or Freeze function is active, cancel it to activate the Input search. It is also unavailable when On-Screen menu is displayed.

**✓Notes:**

- While Input search is set to "On1" or "On2," the status of Input and Lamp are displayed every time the signal is switched.
- Only the last selected input source can be detected.
- If the COMPUTER 1, COMPUTER 2 or VIDEO buttons on the top control or COMPUTER or VIDEO buttons on the remote control is pressed during Input search is in progress, Input search will stop and go back to the previous input signal.

## Power management

For reducing power consumption as well as maintaining the lamp life, the Power management function turns off the projection lamp when the input signal is interrupted and no button is pressed for a certain period.

When the input signal is interrupted and no button is pressed for 30 seconds or more, the timer display with "No signal" message will appear. The countdown will start to turn off the lamp.

Select one of the operations.

Ready .....When the lamp has been fully cooled down, the POWER indicator changes to green blinking. In this condition, the projection lamp will be turned on if the input signal is reconnected or any button on the top control or remote control unit is pressed.

Shut down .....When the lamp has been fully cooled down, the power will be turned off.

Off . . . . .Power management function is off.

Then set the countdown timer with the Point ◀▶ buttons.

### ✓ Note:

Factory default is "Ready: 5 min."

## On start





When this function is "On", the projector will be automatically turned on just by connecting the AC power cord to a wall outlet.

### ✓ Note:

Be sure to turn the projector off properly (see "Turning Off the Projector" on page 20). If the projector is turned off in the incorrect sequence, the On start function does not operate properly.

## Lamp control

This function allows you to change brightness of the screen.

-  Auto ..... The brightness according to the input signal (between High and Eco mode).
-  High ..... Brighter than the Normal mode.
-  Normal ..... Normal brightness
-  Eco ..... Lower brightness reduces the lamp power consumption and extends the lamp life.

## Power management



Time left before Lamp is off.

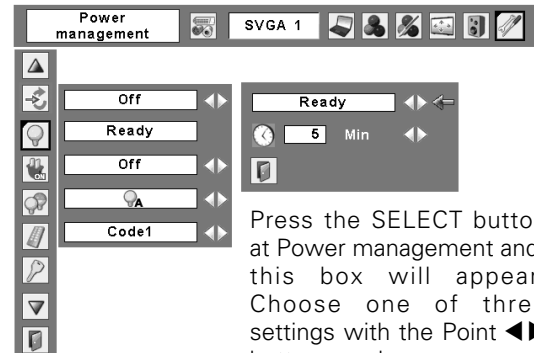

Press the SELECT button at Power management and this box will appear. Choose one of three settings with the Point ◀▶ buttons, and go to the timer with the Point ▲▼ buttons and set time with the Point ◀▶ buttons.

 **Remote control**

This projector provides two different remote control codes; the factory-set, initial code (Code 1) and the secondary code (Code 2). This switching function prevents remote control interference when operating several projectors or video equipment at the same time.

When operating the projector in "Code 2", both the projector and the remote control must be switched to "Code 2".

**To change the code for the projector;**

Select either "Code 1" or "Code 2" in this Setting Menu.

**To change the code for the remote control;**

Press and hold both the MENU and IMAGE buttons together for 10 seconds or more. After changing the code, make sure the remote control operates properly.

**✓ Note:**

*If the batteries are removed from the remote control for a long period of time, the remote control code will be reset.*

**Remote control**

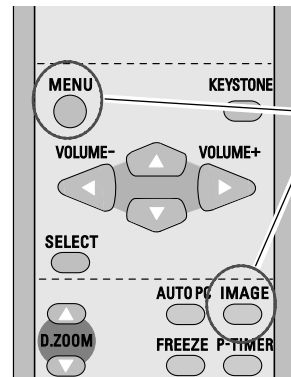

Press and hold MENU and IMAGE buttons for 10 seconds or more.

 **Security (Key lock and PIN code lock settings)**

This function allows you to use Key lock and PIN code lock function to set the security for the projector operation.

 **Key lock**

This function locks operation of the top control or the remote control.

It is useful to prevent operation by an unauthorized person.

 .... not locked.

 .... lock the operation of the top control.  
To unlock, use the remote control.

 .... lock the operation of the remote control.  
To unlock, use the top control.

If the top control accidentally becomes locked and you do not have the remote control nearby or there is something wrong with your remote control, contact the dealer where you purchased the projector or the service center.

**Key lock**

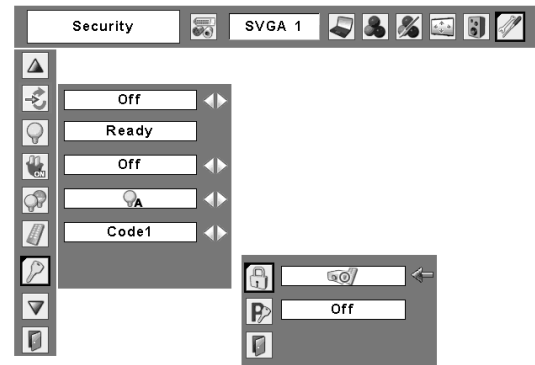

Select Key lock. Choose one of the alternatives with the Point ▲▼ buttons and select [Yes] to activate it.

## PIN code lock

This function prevents the projector from being operated by an unauthorized person and provides the following settings for security options.

- Off.....the projector is not locked with the PIN code.
- On1 .....require to enter the PIN code every time turning on the projector.
- On2 .....require to enter the PIN code to operate the projector once the power cord is disconnected; as long as the AC power cord is connected, the projector can be operated without the PIN code.

Whenever to change the PIN code lock setting or the PIN code (the four-digit number), you are required to enter the PIN code. "1234" is set as the initial PIN code at the factory.

### Enter a PIN code

Use the Point ▲▼ buttons to enter a number. Press the Point ► button to fix the number and move the red frame pointer to the next box. The number changes to "\*" If you fixed an incorrect number, use the Point ◀ button to move the pointer to the number you want to correct, and then enter the correct number.

Repeat this step to complete entering a four-digit number.

After entering the four-digit number, move the pointer to "Set." Press the SELECT button so that you can start to operate the projector.

If you entered an incorrect PIN code, "PIN code" and the number (\*\*\*\*) will turn red for a moment. Enter the correct PIN code all over again.

### Change the PIN code lock setting

Use the Point ◀► button to select Off, On1, or On2 and then move the pointer to "Quit" with the Point ▼ button. Press the SELECT button to close the dialog box.

### Change the PIN code

The PIN code can be changed to your desired four-digit number. Press the Point ▼ buttons to select "PIN code change" and press the SELECT button. The New PIN code input dialog box appears. Set a new PIN code.

#### CAUTION:

**WHEN YOU HAVE CHANGED THE PIN CODE, WRITE DOWN THE NEW PIN CODE IN COLUMN OF THE PIN CODE NO. MEMO ON PAGE 65, AND KEEP IT SECURELY. IF YOU FORGET YOUR PIN CODE, THE PROJECTOR CAN NO LONGER BE STARTED.**

## PIN code lock

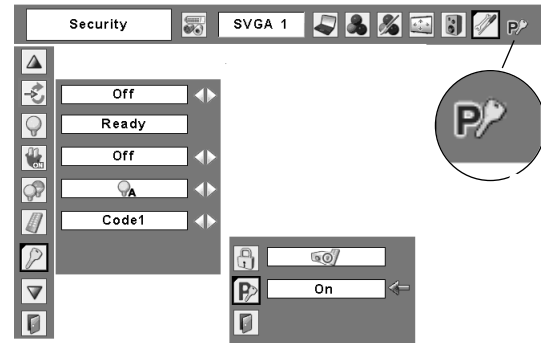

When the projector is locked with the PIN code, the PIN code lock mark appears on the menu bar.

## Enter a PIN code

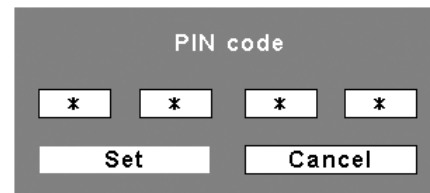

After a correct PIN code is entered, the following dialog box appears.

## Change the PIN code lock setting



Use the Point ◀► buttons to switch between the options.

## Change the PIN code

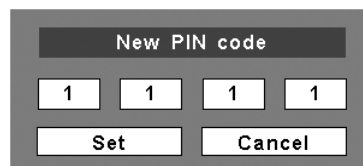





**Fan**

This function provides the following options in the cooling fans' operation when the projector is turned off (p.20).

- L1..... Normal operation
- L2..... Slower and lower-sound than the normal operation (L1), but it takes more time to cool the projector down.



**Fan control**

Choose the running speed of cooling fans from the following options.

- Normal ..... Normal speed
- Max..... Faster than the normal speed.

This function is used to set the cooling fans' operation to the projector's setting environment. Set this function properly in accordance with the projector's installation method. Otherwise, the cooling fans will not work properly and that causes malfunctions of the projector and decreases the lamp life.

Be sure to set the Fan control in MAX in the setting menu when the projector is inclined between +40 degrees to +140 degrees to the horizontal plane.



**Warning log**

This function records anomalous operations while the projector is in operation and use it when diagnosing faults. Up to 10 warning logs are displayed with the latest warning message at the top of the list, followed by previous warning messages in chronological order.

- ✓ **Note:**
- When the Factory default function is executed, all the warning log records will be deleted.



**Lamp counter**

This function is used to reset the lamp counter.

When the lamp life is left less than 100 hours, the Lamp replacement icon (Fig.1) will appear on the screen, indicating that the end of lamp life is approaching.

When the lamp life is counted down to 0 hour, the Lamp replacement icon (Fig.2) will appear on the screen, indicating that the end of lamp life is reached.

When replacing the projection lamp, reset the lamp counter. See "Resetting the Lamp Counter" on page 55.

- ✓ **Note:**
- The Lamp replacement icons (Fig.1 and Fig.2) will not appear when the Display function is set to "Off" (p.42), during "Freeze" (p.24), or "No show" (p.25).

**Fan**

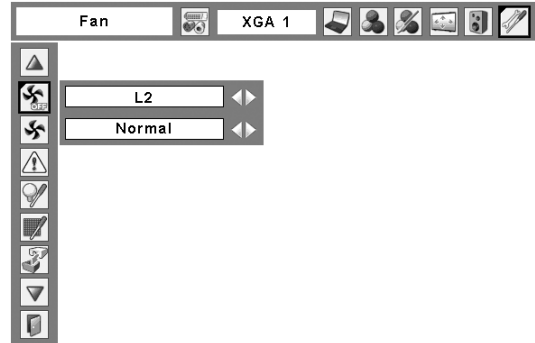

**Fan Control Setting**

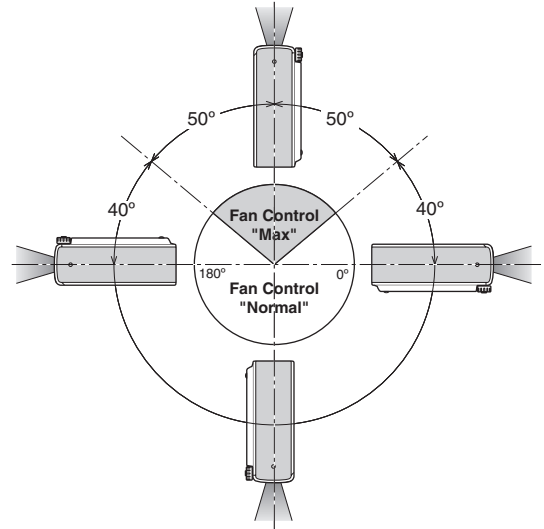

**Fig.1** Lamp replacement icon



This icon appears on the screen when the end of lamp life is approaching.

- ✓ **Note:**
- This icon also appears at turning on and selecting input source.

**Fig.2** Lamp replacement icon



This icon appears on the screen when the end of lamp life is reached.

- ✓ **Note:**
- At turning on, the icon (Fig.2) will appear. At selecting input source, the icon (Fig.1) will appear.

 **Filter counter**

This function is used to set a frequency for the filter cleaning.

When the projector reached a specified time between cleanings, a Filter warning icon appears on the screen, notifying the cleaning is necessary. After cleaning the filter, be sure to select RESET and set the timer. The Filter warning icon will not turn off until the filter counter is reset.

For details about resetting the timer, refer to "Resetting the Filter Counter" on page 52.

**Filter counter**

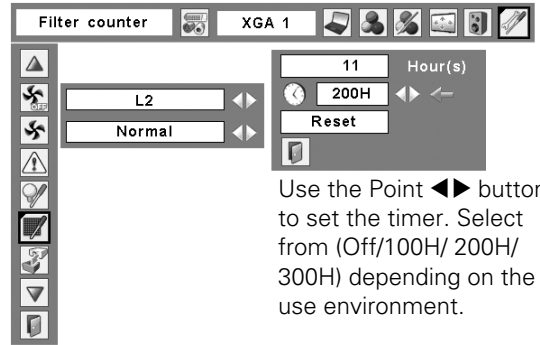

Use the Point ◀▶ buttons to set the timer. Select from (Off/100H/ 200H/ 300H) depending on the use environment.

**Fig.3** Filter warning icon

**Filter warning** 

Filter warning icon appears on the screen at a set time.

**✓ Note:**

- This icon also appears at turning on.

**Fig.4** Filter warning icon



**✓ Notes:**

- At selecting input source, the icon (Fig.4) will appear.
- The Filter warning icons (Fig.3 and Fig.4) will not appear when the Display function is set to "Off" (p.42), during "Freeze" (p.24), or "No show" (p.25).

 **Factory default**

This function returns all setting values except for the user logo, PIN code lock, Logo PIN code lock, lamp counter, and filter counter to the factory default settings.

 **Quit**

Exit the Setting Menu.

**Factory default**

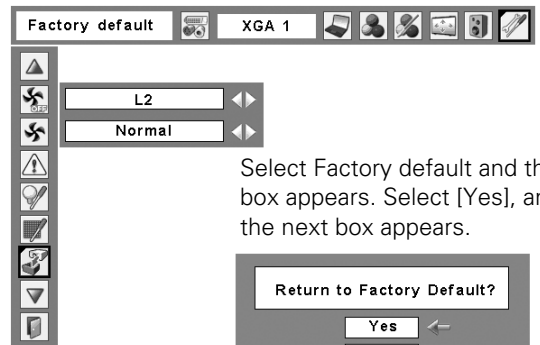

Select Factory default and this box appears. Select [Yes], and the next box appears.

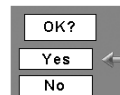

Select [Yes] to activate it.

# Maintenance and Cleaning

## Warning Indicator

The WARNING indicator shows the state of the function which protects the projector. Check the state of the WARNING indicator and the POWER indicator to take proper maintenance.

### **The projector is shut down and the WARNING indicator is blinking red.**

When the temperature inside the projector reaches a certain level, the projector will be automatically shut down to protect the inside of the projector. The POWER indicator is blinking while the projector is being cooled down. When the projector has cooled down enough (to its normal operating temperature), it can be turned on again by pressing the ON/STAND-BY button.

#### ✓ **Note:**

- The WARNING indicator continues to blink even after the temperature inside the projector returns to normal. When the projector is turned on again, the WARNING indicator stops blinking.

#### **Then check the matters below:**

- Did you provide appropriate space for the projector to be ventilated? Check the installing condition to see if the air vents of the projector are not blocked.
- Has the projector been installed near an Air-Conditioning/ Heating Duct or Vent? Move the installation of the projector away from the duct or vent.
- Is the filter clean? Clean the filter periodically.

### **The projector is shut down and the WARNING indicator lights red.**

When the projector detects an abnormal condition, it is automatically shut down to protect the inside of the projector and the WARNING indicator lights red. In this case, unplug the AC power cord and reconnect it, and then turn the projector on once again to verify operation. If the projector cannot be turned on and the WARNING indicator still lights red, unplug the AC power cord and contact the service station.



#### **CAUTION**

DO NOT LEAVE THE PROJECTOR WITH THE AC POWER CORD CONNECTED UNDER AN ABNORMAL CONDITION. IT MAY RESULT IN FIRE OR ELECTRIC SHOCK.

#### Top Control

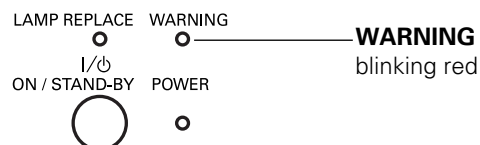

#### Top Control

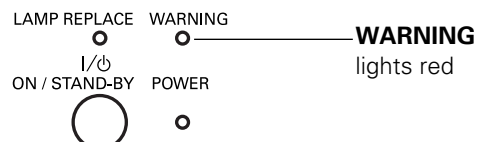

### Cleaning the Filter

Filter prevents dust from accumulating on the optical elements inside the projector. Should the filter becomes clogged with dust particles, it will reduce cooling fans' effectiveness and may result in internal heat buildup and adversely affect the life of the projector. If a "Filter warning" icon appears on the screen, clean the filter immediately. Clean the filter by following the steps below.

- 1 Turn off the projector, and unplug the AC power cord from the AC outlet.
- 2 Turn the projector over and remove the filter by pulling the latches upward.
- 3 Gently clean the filter by using a brush or rinse it softly.
- 4 When rinsing the filter, dry it well. Replace the filter properly. Make sure that the filter is fully inserted to the projector.



#### CAUTION

Do not operate the projector with the filter removed. Dust may accumulate on the optical elements degrading picture quality. Do not put anything into the air vents. Doing so may result in malfunction of the projector.

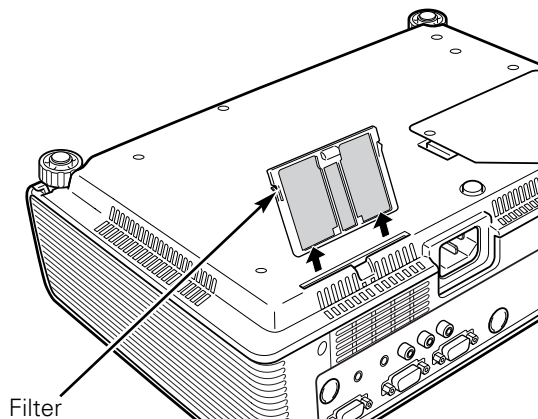

Filter  
Pull up and remove.

#### ✓ Note:

- When reinserting this filter, be sure that the slit part is facing the outer side.

#### RECOMMENDATION

**We recommend avoiding dusty/smoky environments when you operate the projector. Usage in these environments may cause poor image quality.**

When using the projector under dusty or smoky conditions, dust may accumulate on a lens, LCD panels, or optical elements inside the projector degrading the quality of a projected image. When the symptoms above are noticed, contact your authorized dealer or service station for proper cleaning.

### Resetting the Filter Counter

Be sure to reset the Filter counter after cleaning or replacing the filter.

- 1 Press the MENU button to display the On-Screen Menu. Use the Point ◀▶ buttons to move the red frame pointer to the Setting Menu icon.
- 2 Use the Point ▲▼ buttons to move the red frame pointer to Filter counter and then press the SELECT button. A dialog box appears showing the total accumulated time of the filter use, a timer setting option, and the reset option. Select Reset and the "Filter counter Reset?" appears. Select [Yes] to continue.
- 3 Another confirmation dialog box appears, select [Yes] to reset the Filter counter.

#### Filter counter

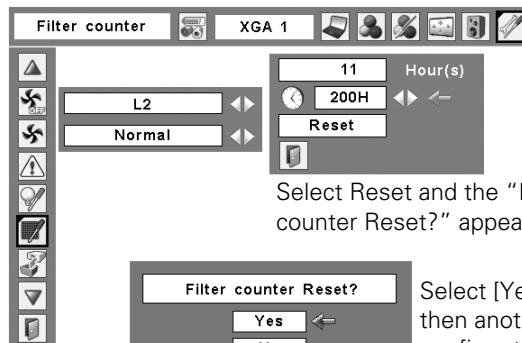

Select Reset and the "Filter counter Reset?" appears.

Select [Yes], then another confirmation box appears.

Select [Yes] again to reset the Filter counter.

### **Slide Shutter**

Slide Shutter is provided to protect the surface of the lens against scratches and dirt. When you are not using the projector, close the Slide Shutter.

To open or close, use the Slide Shutter Lever on the top of the cabinet.

Do not close the shutter when the projection lamp is on.

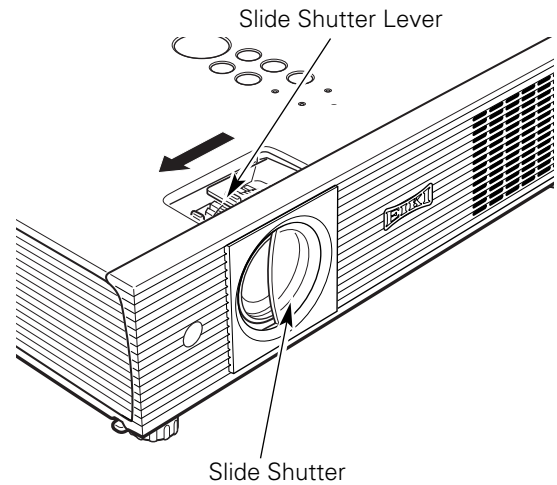

### **Cleaning the Projection Lens**

Unplug the AC power cord before cleaning.

Gently wipe the projection lens with a cleaning cloth that contains a small amount of non-abrasive camera lens cleaner, or use a lens cleaning paper or commercially available air blower to clean the lens.

Avoid using an excessive amount of cleaner. Abrasive cleaners, solvents, or other harsh chemicals might scratch the surface of the lens.

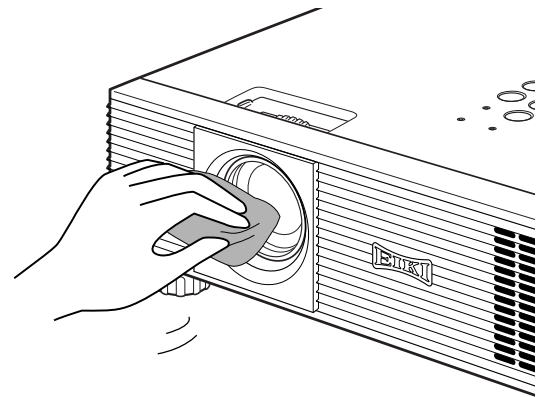

### **Cleaning the Projector Cabinet**

Unplug the AC power cord before cleaning.

Gently wipe the projector body with a soft dry cleaning cloth. When the cabinet is heavily soiled, use a small amount of mild detergent and finish with a soft dry cleaning cloth. Avoid using an excessive amount of cleaner. Abrasive cleaners, solvents, or other harsh chemicals might scratch the surface of the cabinet.

When the projector is not in use, put the projector in an appropriate carrying case to protect it from dust and scratches.

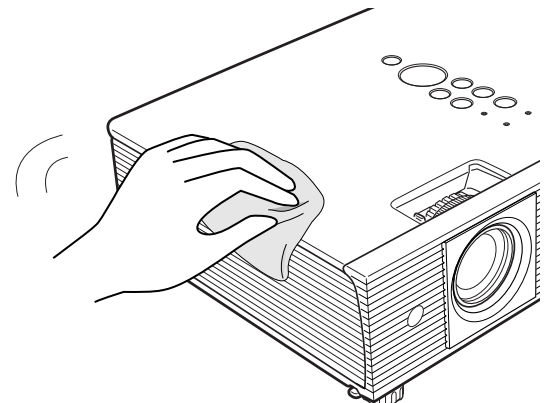

## Lamp Replacement

When the projection lamp of the projector reaches its end of life, the Lamp replacement icon appears on the screen and LAMP REPLACE indicator lights yellow. Replace the lamp with a new one promptly. The timing when the LAMP REPLACE indicator should light is depending on the lamp mode.

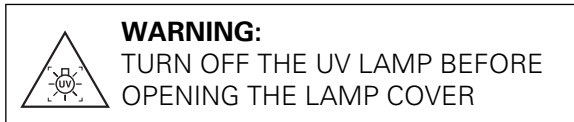

### Top Control

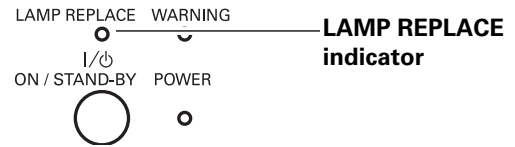

Lamp replacement icon

#### ✓Note:

- The Lamp replacement icon will not appear when the Display function is set to "Off" (p.42), during "Freeze" (p.24), or "No show" (p.25).



### CAUTION

Allow a projector to cool for at least 45 minutes before you open the Lamp cover. The inside of the projector can become very hot.



### CAUTION

For continued safety, replace with a lamp of the same type. Do not drop a lamp or touch a glass bulb! The glass can shatter and may cause injury.

Follow these steps to replace the lamp.

- 1** Turn off the projector and unplug the AC power cord. Let the projector cool for at least 45 minutes.
- 2** Remove the screw and open the lamp cover.
- 3** Remove the two (2) screws that secure the lamp. Lift the lamp out of the projector by using the handle.
- 4** Replace the lamp with a new one and secure the two (2) screws. Make sure that the lamp is set properly. Close the lamp cover and secure the screw.
- 5** Connect the AC power cord to the projector and turn on the projector.
- 6** **Reset the lamp counter.**  
See "Resetting the Lamp Counter" on the next page.

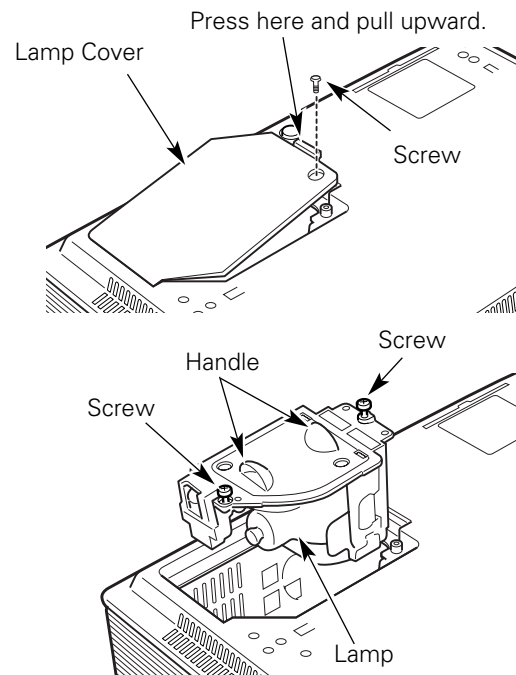

### ORDER REPLACEMENT LAMP

Replacement lamp can be ordered through your dealer. When ordering a projection lamp, give the following information to the dealer.

- **Model No. of your projector** : LC-XB41
- **Replacement Lamp Type No.** : POA-LMP111  
(Service Parts No. 610 333 9740)

## Resetting the Lamp Counter

Be sure to reset the Lamp counter after the lamp is replaced. When the Lamp counter is reset, the LAMP REPLACE indicator stops lighting and the Lamp replacement icon disappears.

- 1 Press the MENU button to display the On-Screen Menu. Use the Point ◀▶ buttons to move the red frame pointer to the Setting Menu icon.
- 2 Use the Point ▲▼ buttons to move the red frame pointer to Lamp counter and then press the SELECT button. A dialog box appears showing the total accumulated time of the lamp usage and the reset option. Select Reset and the "Lamp replacement counter Reset?" appears. Select [Yes] to continue.
- 3 Another confirmation dialog box appears, select [Yes] to reset the Lamp counter.

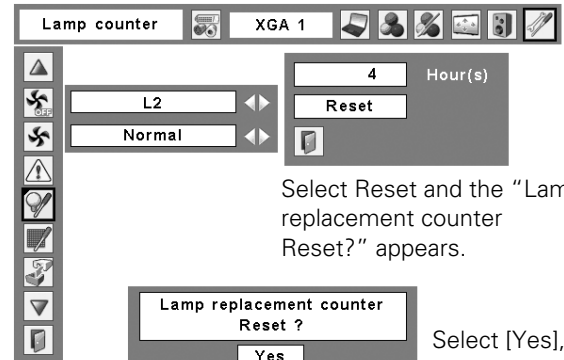

Select Reset and the "Lamp replacement counter Reset?" appears.

Select [Yes], then another confirmation box appears.

Select [Yes] again to reset the Lamp counter.

**✓Note:**

- Do not reset the Lamp counter without implementing lamp replacement. Be sure to reset the Lamp counter only after replacing the lamp.



## LAMP HANDLING PRECAUTIONS

This projector uses a high-pressure lamp which must be handled carefully and properly. Improper handling may result in accidents, injury, or create a fire hazard.

- Lamp life may differ from lamp to lamp and according to the environment of use. There is no guarantee of the same life for each lamp. Some lamps may fail or terminate their life in a shorter period of time than other similar lamps.
- If the projector indicates that the lamp should be replaced, i.e., if the LAMP REPLACE indicator lights up, replace the lamp with a new one IMMEDIATELY after the projector has cooled down. (Follow carefully the instructions in the Lamp Replacement section of this manual.) Continuous use of the lamp with the LAMP REPLACE indicator lighted may increase the risk of lamp explosion.
- A Lamp may explode as a result of vibration, shock or degradation as a result of hours of use as its lifetime draws to an end. Risk of explosion may differ according to the environment or conditions in which the projector and lamp are being used.

### IF A LAMP EXPLODES, THE FOLLOWING SAFETY PRECAUTIONS SHOULD BE TAKEN.

If a lamp explodes, disconnect the projector's AC plug from the AC outlet immediately. Contact an authorized service station for a checkup of the unit and replacement of the lamp. Additionally, check carefully to ensure that there are no broken shards or pieces of glass around the projector or coming out from the cooling air circulation holes. Any broken shards found should be cleaned up carefully. No one should check the inside of the projector except those who are authorized trained technicians and who are familiar with projector service. Inappropriate attempts to service the unit by anyone, especially those who are not appropriately trained to do so, may result in an accident or injury caused by pieces of broken glass.

# Appendix

## Troubleshooting

Before calling your dealer or service center for assistance, check the items below once again.

- Make sure you have properly connected the projector to peripheral equipment as described on page15-17.
- Make sure all equipment is connected to AC outlet and the power is turned on.
- When you operate the projector with a computer and it does not project an image, restart the computer.

---

**Problem:**

- Solutions

---

**No power**

- Plug the power cord of the projector into the AC outlet.
  - See if the POWER indicator lights red.
  - Wait 90-120 seconds after the projector is turned off when turning the projector back on. The projector can be turned on after the POWER indicator turns red. (See on page 20.)
  - Check the WARNING indicator. If the WARNING indicator lights red, the projector cannot be turned on. (See on page 51.)
  - Check the projection lamp. (See page 54.)
  - Unlock Key lock for the projector Key lock function. (See page 47.)
- 

**Image is out of focus.**

- Adjust focus of the projector. (See page 23.)
  - Provide proper distance between the projector and the projection screen. (See page 14.)
  - Check the projection lens to see if it needs cleaning. (See page 53.)
  - Moving the projector from a cool to a warm place may result in moisture condensation on the projection lens. In such cases, leave the projector off and wait until condensation evaporates.
- 

**No image**

- Check the connection between your computer or video equipment and the projector. (See pages 15-17)
  - See if the input signal is correctly output from your computer. Some laptop computers may need to change the setting for monitor output when connecting to a projector. See your computer's instruction manual for the setting.
  - It takes about 30 seconds to display an image after turning on the projector.
  - See if the selected system is corresponding with your computer or video equipment. (See pages 27 and 37)
  - Select correct input source once again through menu operation. (See pages 26 ,35 and 36)
  - Make sure the temperature is not out of the specified Operating Temperature {41 °F ~ 95 °F (5 °C ~ 35 °C)} .
- 

**Image is Left/Right reversed.  
Image is Top/Bottom reversed.**

- Check the Ceiling / Rear function. (See page 45.)
  - Check the Ceiling function. (See page 45.)
- 

**No sound**

- Check audio cable connection from audio input source.
  - Adjust the audio source.
  - Press the Volume+ button. (See page 23.)
  - Press the Mute button. (See page 23.)
  - Is the image projected? You will hear the sound only when the image is projected.
-



---

<b><i>Some displays are not seen during the operation.</i></b>	-Check the Display function. (See page 42.)
--	---

---

<b><i>PIN code dialog box appears at start-up.</i></b>	-PIN code lock is being set. Input a PIN code (1234 or numbers you have set). (See pages 19 and 48.)
--	--

---

<b><i>The Remote Control does not work.</i></b>	<ul style="list-style-type: none"> <li>-Check the batteries.</li> <li>-Make sure no obstruction is between the projector and remote control.</li> <li>-Make sure you are not too far from the projector when using the remote control. Maximum operating range is 16.4' (5m).</li> <li>-Make sure the code of the remote control is conformed to the projector. (See page 47.)</li> <li>-Unlock Key lock for the remote control in the Key lock function. (See page 47.)</li> </ul>
---	---

---

**WARNING :**

**High voltages are used to operate this projector. Do not attempt to open the cabinet.**

If problems still persist after following all operating instructions, contact the dealer where you purchased the projector or the service center. Give the model number and explain about the problem. We will advise you how to obtain service.

 The CE Mark is a Directive conformity mark of the European Community (EC).



This symbol on the nameplate means the product is Listed by Underwriters Laboratories Inc. It is designed and manufactured to meet rigid U.L. safety standards against risk of fire, casualty and electrical hazards.

# Menu Tree

## Computer Input / Video Input

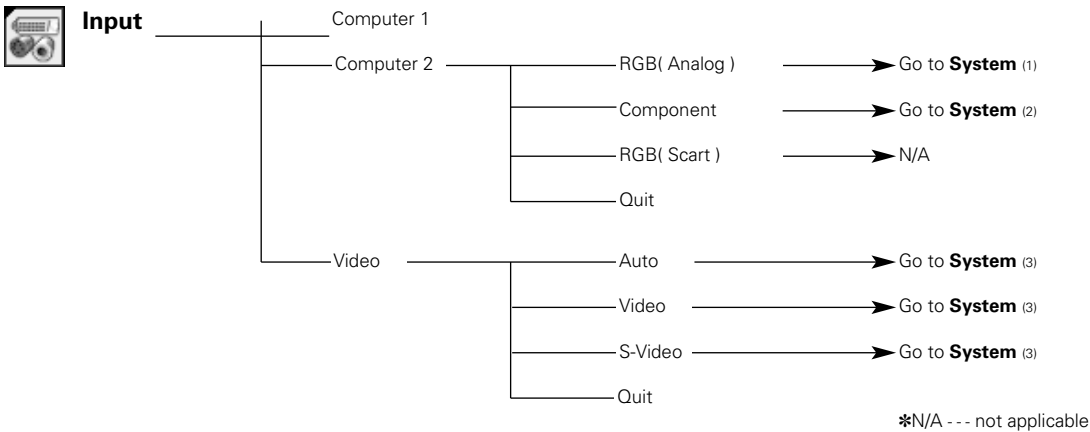

## Sound

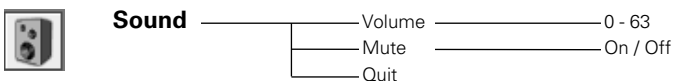

## Computer Input

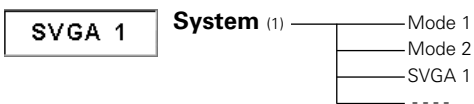

\*Systems displayed in the System Menu vary depending on an input signal.

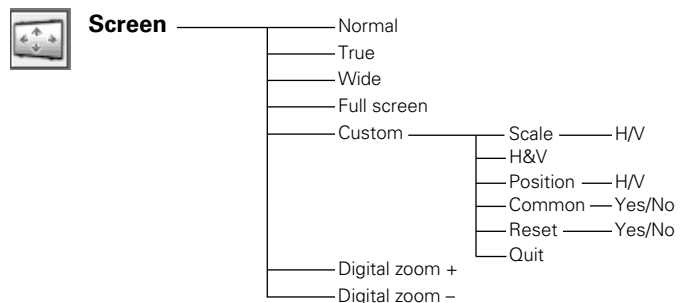
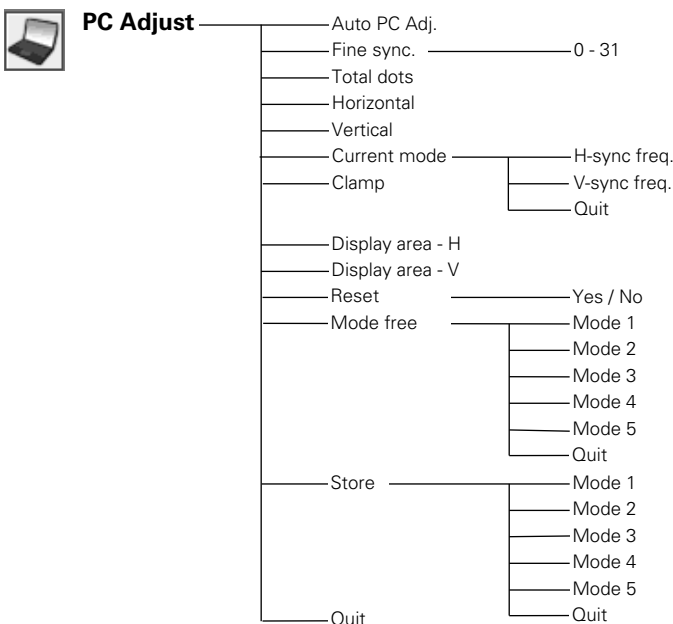
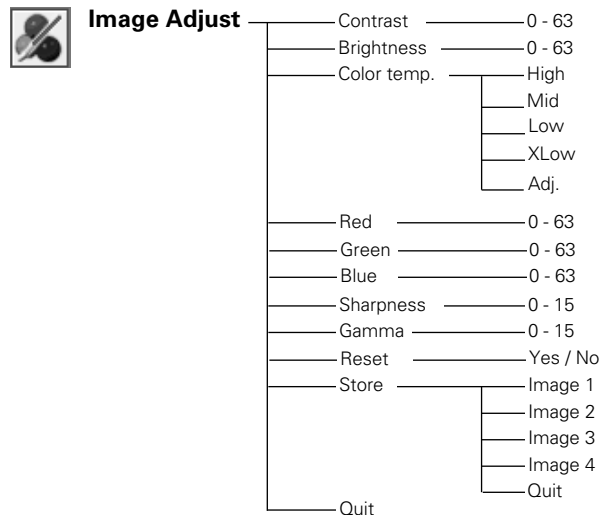
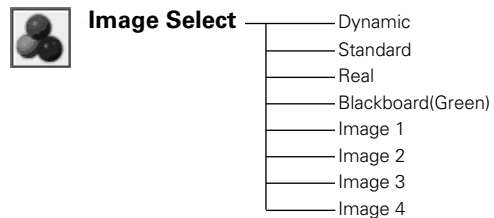

## Video Input

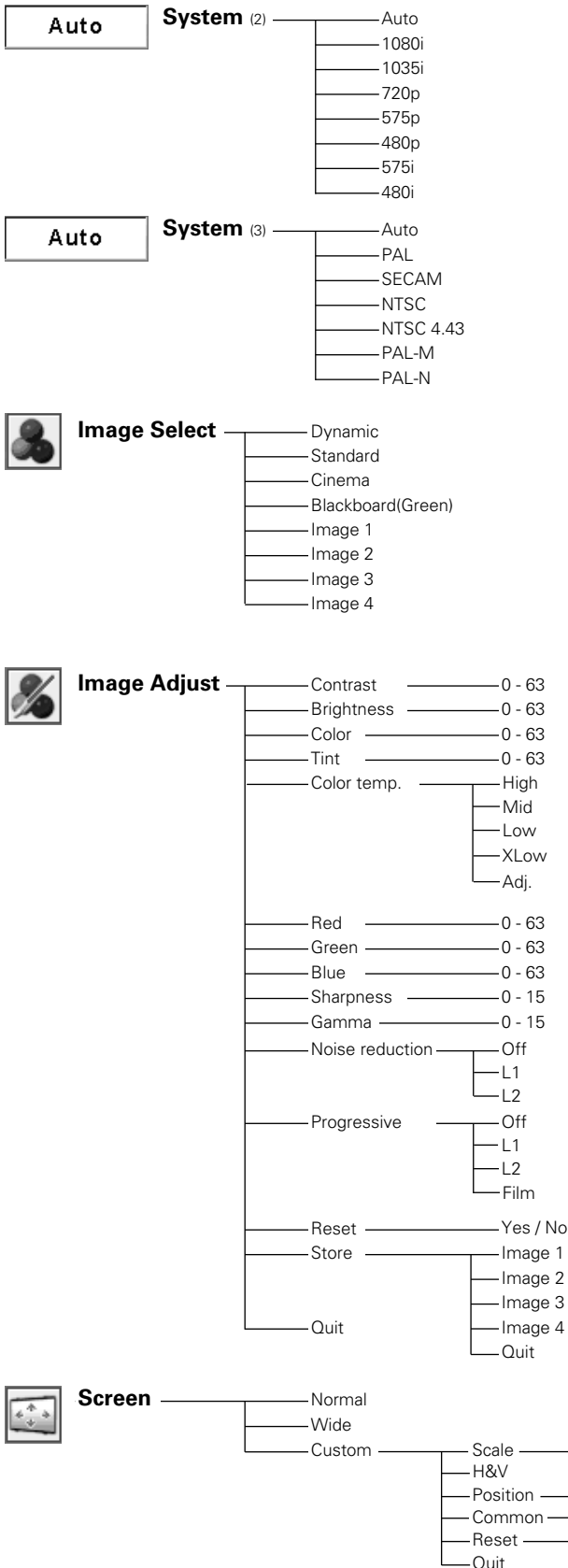

## Setting

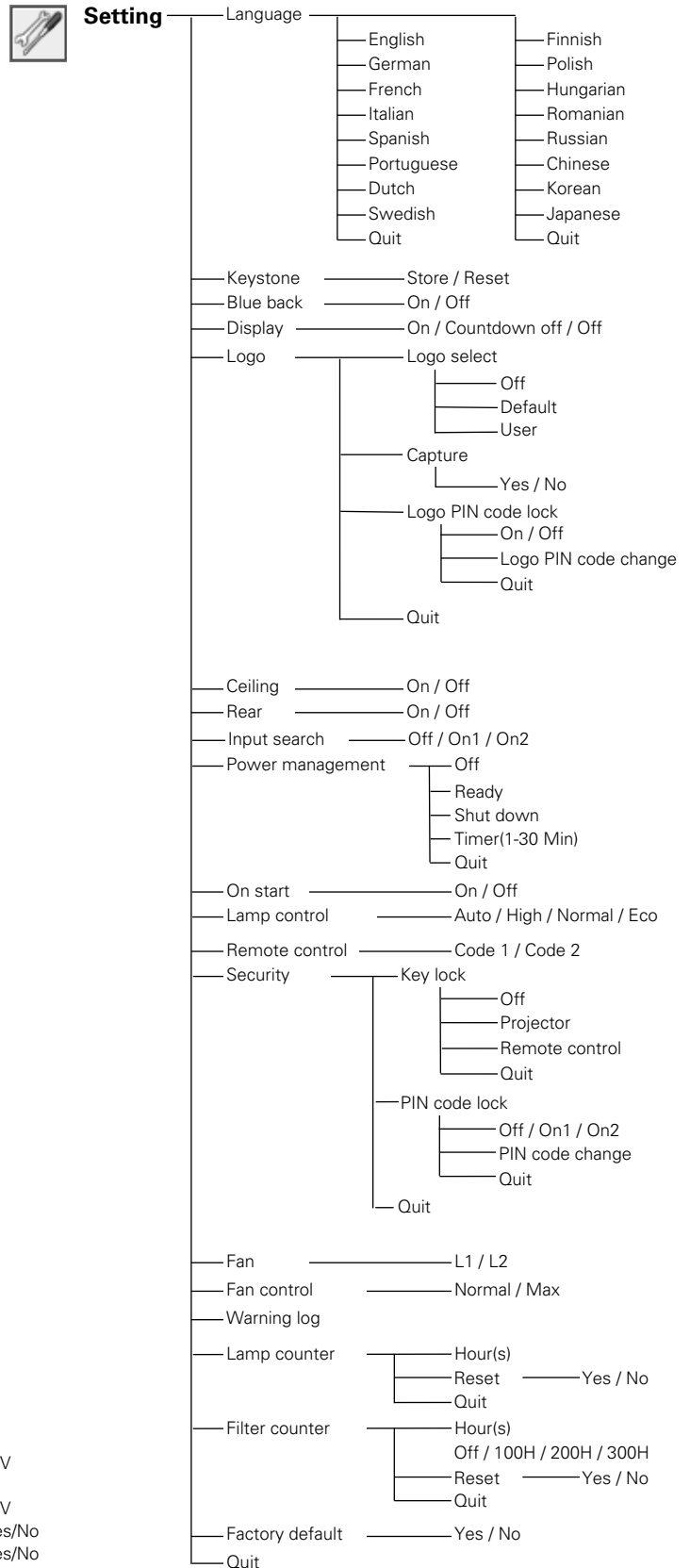

## Indicators and Projector Condition

Check the indicators for projector condition.

Indicators			Projector Condition
POWER red/green	WARNING red	LAMP REPLACE yellow	
●	●	●	The projector is off. (The AC power cord is unplugged.)
⦿	●	*	The projector is preparing for stand-by or the projection lamp is being cooled down. The projector cannot be turned on until cooling is completed.
⦿	●	*	The projector is ready to be turned on with the ON/STAND-BY button.
○	●	*	The projector is operating normally.
⦿	●	*	The projector is in the Power management mode.
⦿	⦿	*	The temperature inside the projector is abnormally high. The projector cannot be turned on. When the projector is cooled down enough and the temperature returns to normal, the POWER indicator emits a red light and the projector can be turned on. (The WARNING indicator keeps blinking.) Check and clean the air filters.
⦿	⦿	*	The projector has been cooled down enough and the temperature returns to normal. When turning on the projector, the WARNING indicator stops blinking. Check and clean the air filters.
●	⦿	*	The projector detects an abnormal condition and cannot be turned on. Unplug the AC power cord and plug it again to turn on the projector. If the projector is turned off again, disconnect the AC power cord and contact the dealer or the service center for service and checkup. Do not leave the projector on. It may cause an electric shock or a fire hazard.

○ ●●● green.

⦿ ●●● red

● ●●● off

⦿ ●●● blinks green.

⦿ ●●● blinks red.

\* When the life of the projection lamp draws to an end, the LAMP REPLACE indicator lights yellow. When this indicator lights yellow, replace the projection lamp with a new one promptly. Reset the lamp replacement counter after replacement of the lamp. See page 54 and 55.

## Compatible Computer Specifications

The projector can basically accept the signal from all computers with the V, H-Frequency mentioned below and less than 140 MHz of Dot Clock.

ON-SCREEN DISPLAY	RESOLUTION	H-Freq. (kHz)	V-Freq. (Hz)	ON-SCREEN DISPLAY	RESOLUTION	H-Freq. (kHz)	V-Freq. (Hz)
VGA 1	640 x 480	31.47	59.88	SXGA 1	1152 x 864	64.20	70.40
VGA 2	720 x 400	31.47	70.09	SXGA 2	1280 x 1024	62.50	58.60
VGA 3	640 x 400	31.47	70.09	SXGA 3	1280 x 1024	63.90	60.00
VGA 4	640 x 480	37.86	74.38	SXGA 4	1280 x 1024	63.34	59.98
VGA 5	640 x 480	37.86	72.81	SXGA 5	1280 x 1024	63.74	60.01
VGA 6	640 x 480	37.50	75.00	SXGA 6	1280 x 1024	71.69	67.19
VGA 7	640 x 480	43.269	85.00	SXGA 7	1280 x 1024	81.13	76.107
MAC LC13	640 x 480	34.97	66.60	SXGA 8	1280 x 1024	63.98	60.02
MAC 13	640 x 480	35.00	66.67	SXGA 9	1280 x 1024	79.976	75.025
480i	————	15.734	60.00 (Interface)	SXGA 10	1280 x 960	60.00	60.00
575i	————	15.625	50.00 (Interface)	SXGA 11	1152 x 900	61.20	65.20
SVGA 1	800 x 600	35.156	56.25	SXGA 12	1152 x 900	71.40	75.60
SVGA 2	800 x 600	37.88	60.32	SXGA 13	1280 x 1024	50.00	86.00 (Interface)
SVGA 3	800 x 600	46.875	75.00	SXGA 14	1280 x 1024	50.00	94.00 (Interface)
SVGA 4	800 x 600	53.674	85.06	SXGA 15	1280 x 1024	63.37	60.01
SVGA 5	800 x 600	48.08	72.19	SXGA 16	1280 x 1024	76.97	72.00
SVGA 6	800 x 600	37.90	61.03	SXGA 17	1152 x 900	61.85	66.00
SVGA 7	800 x 600	34.50	55.38	SXGA 18	1280 x 1024	46.43	86.70 (Interface)
SVGA 8	800 x 600	38.00	60.51	SXGA 19	1280 x 1024	63.79	60.18
SVGA 9	800 x 600	38.60	60.31	SXGA 20	1280 x 1024	91.146	85.024
SVGA 10	800 x 600	32.70	51.09	SXGA +1	1400 x 1050	63.97	60.19
SVGA 11	800 x 600	38.00	60.51	SXGA +2	1400 x 1050	65.35	60.12
MAC 16	832 x 624	49.72	74.55	SXGA +3	1400 x 1050	65.12	59.90
XGA 1	1024 x 768	48.36	60.00	MAC21	1152 x 870	68.68	75.06
XGA 2	1024 x 768	68.677	84.997	MAC	1280 x 960	75.00	75.08
XGA 3	1024 x 768	60.023	75.03	MAC	1280 x 1024	80.00	75.08
XGA 4	1024 x 768	56.476	70.07	480p	————	31.47	59.88
XGA 5	1024 x 768	60.31	74.92	575p	————	31.25	50.00
XGA 6	1024 x 768	48.50	60.02	720p	————	45.00	60.00
XGA 7	1024 x 768	44.00	54.58	1035i	————	33.75	60.00 (Interface)
XGA 8	1024 x 768	63.48	79.35	1080i	————	33.75	60.00 (Interface)
XGA 9	1024 x 768	36.00	87.17 (Interface)	1080i	————	28.125	50.00 (Interface)
XGA 10	1024 x 768	62.04	77.07	WXGA 1	1366 x 768	48.36	60.00
XGA 11	1024 x 768	61.00	75.70	WXGA 2	1360 x 768	47.70	60.00
XGA 12	1024 x 768	35.522	86.96 (Interface)	WXGA 3	1376 x 768	48.36	60.00
XGA 13	1024 x 768	46.90	58.20	WXGA 4	1360 x 768	56.16	72.00
XGA 14	1024 x 768	47.00	58.30	WXGA 6	1280 x 768	47.776	59.87
XGA 15	1024 x 768	58.03	72.00	WXGA 7	1280 x 768	60.289	74.893
MAC 19	1024 x 768	60.24	75.08	WXGA 8	1280 x 768	68.633	84.837
				UXGA 1	1600 x 1200	75.00	60.00
				UXGA 2	1600 x 1200	81.25	65.00
				UXGA 3	1600 x 1200	87.5	70.00
				UXGA 4	1600 x 1200	93.75	75.00

\*1

\*1

\*1

\*1

\*1

\*1 When selecting these modes, PC adjustment can be limited.

## Technical Specifications

### Mechanical Information

---

Projector Type	Multi-media Projector
Dimensions (W x H x D)	13.15" x 3.07" x 9.17" (334 mm x 78 mm x 233 mm) (Not including adjustable feet)
Net Weight	7.5 lbs (3.3 kg)
Feet Adjustment	0° to approx. 9°

### Panel Resolution

---

LCD Panel System	0.8" TFT Active Matrix type, 3 panels
Panel Resolution	1,024 x 768 dots
Number of Pixels	2,359,296 (1,024 x 768 x 3 panels)

### Signal Compatibility

---

Color System	PAL, SECAM, NTSC, NTSC4.43, PAL-M, PAL-N
High Definition TV Signal	480i, 480p, 575i, 575p, 720p, 1035i, and 1080i
Scanning Frequency	H-sync. 15 kHz ~ 100 kHz, V-sync. 50 ~ 100 Hz

### Optical Information

---

Projection Image Size (Diagonal)	Adjustable from 33" to 300"
Throw Distance	4.3'–32.8' (1.3 m–10.0 m)
Projection Lens	F1.7–2.1 lens with f26.7 mm–32.0 mm with manual zoom and focus
Projection Lamp	275 W

### Interface

---

Video Input Jack	RCA Type x 1
S-Video Input Jack	Mini DIN 4 pin x 1
Audio Input Jacks	RCA Type x 2
Computer Input 1 Terminal	Analog RGB (Mini D-sub 15 pin) Terminal X 1
Computer Input 2 / Component Input Terminal	Analog RGB (Mini D-sub 15 pin) Terminal X 1
Computer/ Component Audio Input Jack	Mini Jack (stereo) x 1
Monitor Output	Analog RGB (Mini D-sub 15 pin) Terminal X 1
Service Port Connector	Mini DIN 8 pin x 1
Audio Output Jack	Mini Jack (stereo) x 1 (Variable)

### Audio

---

Internal Audio Amp	1.0W RMS
Built-in Speaker	1 speaker, ø1.1" (28mm)

### Power

---

Voltage and Power Consumption	AC 100 ~ 120 V (4.9A Max. Ampere), 50 / 60 Hz (The U.S.A and Canada) AC 200 ~ 240 V (2.2A Max. Ampere), 50 / 60 Hz (Continental Europe and The U.K.)
-------------------------------	---

### Operating Environment

---

Operating Temperature	41 °F ~ 95 °F (5 °C ~ 35 °C)
Storage Temperature	14 °F ~ 140 °F (-10°C ~ 60 °C)

### Remote Control

---

Battery	AA or LR6 1.5V ALKALINE TYPE x 2
Operating Range	16.4' (5m) / ±30°
Dimensions	1.9" (W) x 0.87" (H) x 5.7" (D) (49mm x 22mm x 145.3mm)
Net Weight	3.53 oz (100 g) (including batteries)

## Accessories

---

Owner's Manual (CD-ROM)  
Quick Reference Guide  
AC Power Cord  
Remote Control and Batteries  
VGA Cable  
PIN Code Label

- The specifications are subject to change without notice.
- LCD panels are manufactured to the highest possible standards. Even though 99.99% of the pixels are effective, a tiny fraction of the pixels (0.01% or less) may be ineffective by the characteristics of the LCD panels.

## Optional Parts

The parts listed below are optionally available. When ordering those parts, give the item name and Model No. to the sales dealer.

	<i>Model No.</i>
<b>COMPONENT-VGA Cable</b>	: AH-98771
<b>SCART-VGA Cable</b>	: AH-98881
<b>Soft Carrying Case</b>	: AH-82201

## Configurations of Terminals

### COMPUTER INPUT/COMPONENT INPUT/MONITOR OUTPUT TERMINAL (ANALOG)

Terminal : Analog RGB (Mini D-sub 15 pin)

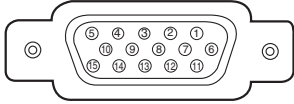

1	Red (R/Cr) Input / Output	9	5V
2	Green (G/Y) Input / Output	10	Ground (Vert.sync.)
3	Blue (B/Cb) Input / Output	11	Ground
4	---	12	DDC data
5	Ground (Horiz.sync.)	13	Horiz. sync. Input/Output (Composite H/V sync.)
6	Ground (Red)	14	Vert. sync.
7	Ground (Green)	15	DDC clock
8	Ground (Blue)		

### SERVICE PORT CONNECTOR

Terminal : Mini DIN 8-PIN

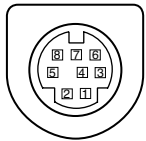

	Serial
1	R X D
2	---
3	---
4	GND
5	RTS / CTS
6	T X D
7	GND
8	GND

## Dimensions

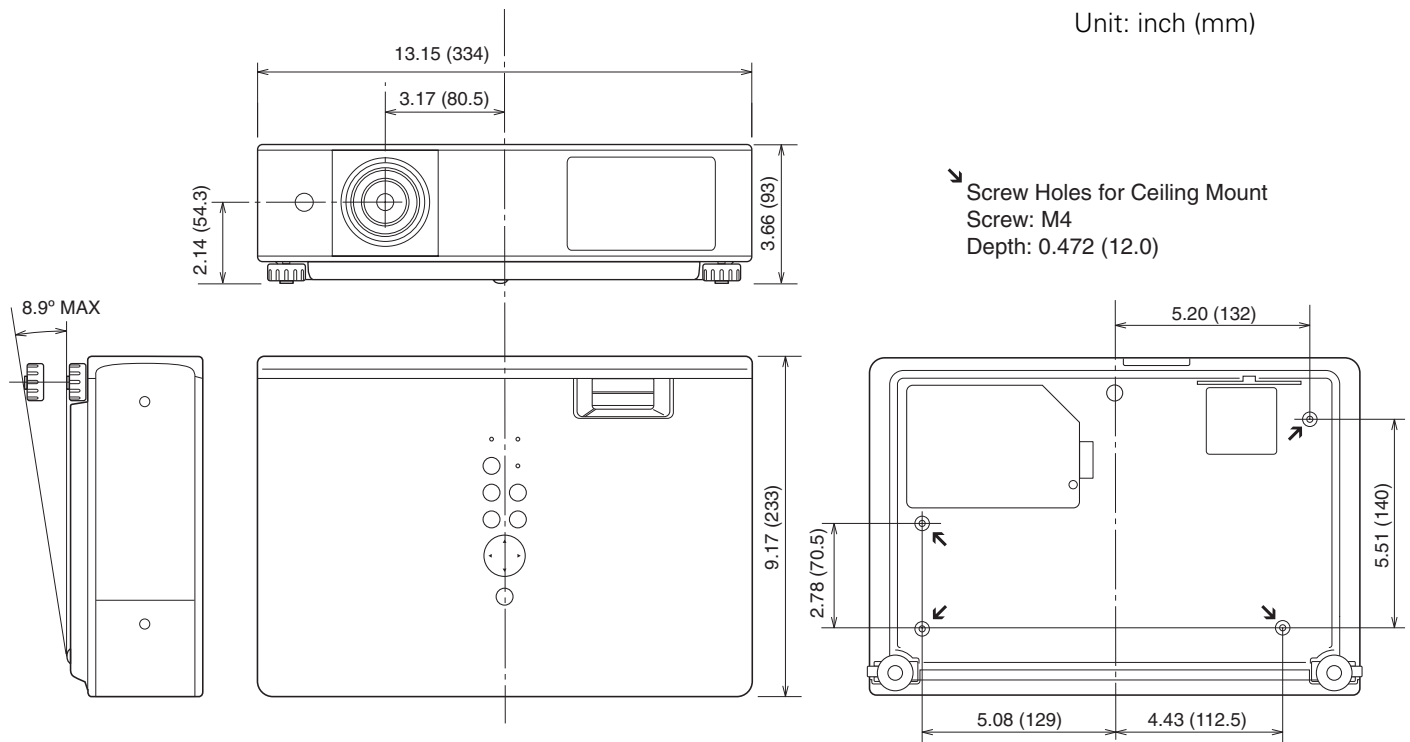



## ***PIN Code Number Memo***

Write down the PIN code number in the column below and keep it with this manual securely. If you forgot or lost the number and unable to operate the projector, contact the service station.

**PIN Code Lock No.**

--	--	--	--

Factory default set No: 1 2 3 4\*

**Logo PIN Code Lock No.**

--	--	--	--

Factory default set No: 4 3 2 1\*

\*Should the four-digit number be changed, the factory set number will be invalid.

While the projector is locked with the PIN code...

Put the label below (supplied) on in a prominent place of the projector's body while it is locked with a PIN code.

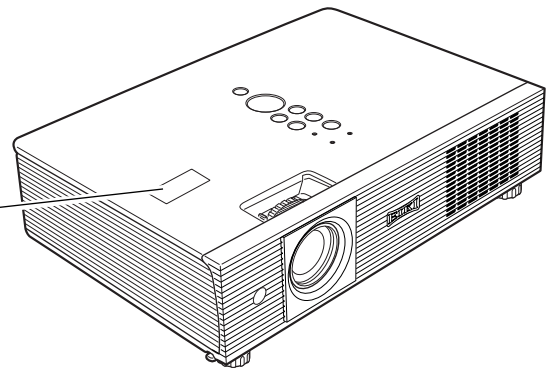

# EIKI

## **U.S.A.**

EIKI International, Inc.  
30251 Esperanza  
Rancho Santa Margarita  
CA 92688-2132  
U.S.A.  
Tel : 800-242-3454 (949)-457-0200  
Fax : 800-457-3454 (949)-457-7878  
E-Mail : usa@eiki.com

## **Deutschland & Österreich**

EIKI Deutschland GmbH  
Am Frauwald 12  
65510 Idstein  
Deutschland  
Tel : 06126-9371-0  
Fax : 06126-9371-14  
E-Mail : info@eiki.de

## **China**

EIKI (Shanghai) Co.,LTD  
1. Dapu Road, Golden Magnolia Plaza  
#2109 Shanghai,  
200023 China  
Tel : 86-21-5396-0088  
Fax : 86-21-5396-0318  
E-Mail : info@eikichina.com.cn

## **Canada**

EIKI CANADA - Eiki International, Inc.  
P.O. Box 156, 310 First St. - Unit 2,  
Midland, ON, L4R 4K8, Canada  
Tel : 800-563-3454 (705)-527-4084  
Fax : 800-567-4069 (705)-527-4087  
E-Mail : canada@eiki.com

## **Eastern Europe**

EIKI CZECH spol. s.r.o.  
Umělecká 15  
170 00 Praha 7  
Czech Republic  
Tel : +42 02 20570024  
+42 02 20571413  
Fax : +42 02 20571411  
E-Mail : easterneurope@eiki.de

## **Japan & Worldwide**

EIKI Industrial Company Limited.  
4-12 Banzai-Cho, Kita-Ku, Osaka,  
530-0028 Japan  
Tel : +81-6-6311-9479  
Fax : +81-6-6311-8486

**WorldWide Website <http://www.eiki.com>**